



# 目 录

|                              |            |
|------------------------------|------------|
| <b>一、运输作业组织与管理模块.....</b>    | <b>2</b>   |
| 1.                           | 1-1        |
| 2.                           | 1-2        |
| 3.                           | 1-3        |
| 4.                           | 1-4        |
| 5.                           | 1-5        |
| 6.                           | 1-6        |
| 7.                           | 1-7        |
| 8.                           | 1-8        |
| 9.                           | 1-9        |
| 10.                          | 1-10       |
| <b>二、仓储与配送作业组织与管理模块.....</b> | <b>34</b>  |
| 1.                           | 2-1        |
| 2.                           | 2-2        |
| 3.                           | 2-3        |
| 4.                           | 2-4        |
| 5.                           | 2-5        |
| 6.                           | 2-6        |
| 7.                           | 2-7        |
| 8.                           | 2-8        |
| 9.                           | 2-9        |
| 10.                          | 2-10       |
| 11.                          | 2-11       |
| 12.                          | 2-12       |
| 13.                          | 2-13       |
| 14.                          | 2-14       |
| 15.                          | 2-15       |
| 16.                          | 2-16       |
| 17.                          | 2-17       |
| 18.                          | 2-18       |
| 19.                          | 2-19       |
| 20.                          | 2-20       |
| <b>三、国际物流作业组织与管理模块.....</b>  | <b>150</b> |
| 1.                           | 3-1        |
| 2.                           | 3-2        |
| 3.                           | 3-3        |
| 4.                           | 3-4        |
| 5.                           | 3-5        |
| 6.                           | 3-6        |
| 7.                           | 3-7        |
| 8.                           | 3-8        |
| 9.                           | 3-9        |

|     |      |
|-----|------|
| 10. | 3-10 |
| 11. | 3-11 |
| 12. | 3-12 |
| 13. | 3-13 |
| 14. | 3-14 |
| 15. | 3-15 |
| 16. | 3-16 |
| 17. | 3-17 |
| 18. | 3-18 |
| 19. | 3-19 |
| 20. | 3-20 |
| 21. | 3-21 |
| 22. | 3-22 |
| 23. | 3-23 |
| 24. | 3-24 |
| 25. | 3-25 |

**四、 快递物流作业组织与管理模块..... 213**

|     |      |
|-----|------|
| 1.  | 4-1  |
| 2.  | 4-2  |
| 3.  | 4-3  |
| 4.  | 4-4  |
| 5.  | 4-5  |
| 6.  | 4-6  |
| 7.  | 4-7  |
| 8.  | 4-8  |
| 9.  | 4-9  |
| 10. | 4-10 |
| 11. | 4-11 |
| 12. | 4-12 |
| 13. | 4-13 |
| 14. | 4-14 |
| 15. | 4-15 |
| 16. | 4-16 |
| 17. | 4-17 |
| 18. | 4-18 |
| 19. | 4-19 |
| 20. | 4-20 |
| 21. | 4-21 |
| 22. | 4-22 |
| 23. | 4-23 |
| 24. | 4-24 |
| 25. | 4-25 |

# 湖南商务职业技术学院物流管理专业学生技能考核题库

4

13

| 1 |  |  |     | 7  |
|---|--|--|-----|----|
|   |  |  |     | 1  |
|   |  |  |     | 1  |
|   |  |  |     | 1  |
| 2 |  |  | ABC | 10 |
|   |  |  |     | 5  |
|   |  |  |     | 5  |
| 3 |  |  |     | 8  |
|   |  |  |     | 8  |
|   |  |  |     | 9  |
| 4 |  |  |     | 10 |
|   |  |  |     | 5  |
|   |  |  |     | 10 |

# 一、运输作业组织与管理模块

1. 1-1

(1)

|      |       |        |     |     |
|------|-------|--------|-----|-----|
| 4538 |       | MB1.2/ | 88  | 360 |
|      | MB145 |        | 100 | 100 |

①

20

②

10

③

20

|  |  |  |
|--|--|--|
|  |  |  |
|--|--|--|

④

⑤

15

2

|    |    |         |
|----|----|---------|
|    |    |         |
|    | 2  | 30      |
|    |    | 1 30 40 |
| 0  | 5  |         |
|    | 30 |         |
| 30 | 2  |         |

3

60

4

2

100

20%

80%

1

1

|  |  |  |  |  |
|--|--|--|--|--|
|  |  |  |  |  |
|--|--|--|--|--|

|       |    |  |   |   |
|-------|----|--|---|---|
| (20 ) | 5  |  | 2 | 0 |
|       | 5  |  | 3 |   |
|       | 10 |  | 2 |   |
| (80 ) | 20 |  | 3 | 5 |
|       | 15 |  | 5 | 5 |
|       | 10 |  | 5 | 5 |
|       | 15 |  | 8 | 7 |
|       | 20 |  | 1 |   |

## 2. 1-2

### (1) 任务描述

|         |       |       |       |
|---------|-------|-------|-------|
| 1.2 / . | 25    | 5123  |       |
|         | 330   |       | 165 ( |
|         | 100   | 100   |       |
|         | 333 ) |       |       |
| 1       |       | >=300 |       |
|         | <2    | 98%   |       |
| 2<=     | <4    | 96%   |       |
| 4<=     | <6    | 94%   |       |
|         | >=6   | 92%   |       |
| 2       |       | <300  |       |
|         | <2    | 100%  |       |
| 2<=     | <4    | 98%   |       |
| 4<=     | <6    | 96%   |       |
|         | >=6   | 94%   |       |

:

①

20

②

③



④

|   |  |  |   |  |  |   |  |  |
|---|--|--|---|--|--|---|--|--|
|   |  |  |   |  |  |   |  |  |
|   |  |  |   |  |  |   |  |  |
|   |  |  |   |  |  |   |  |  |
|   |  |  |   |  |  |   |  |  |
|   |  |  |   |  |  |   |  |  |
| <input type="checkbox"/> <input type="checkbox"/> |  |  | <input type="checkbox"/> <input type="checkbox"/> |  |  |   |  |  |
| <input type="checkbox"/> <input type="checkbox"/> |  |  |   |  |  |   |  |  |
|   |  |  |   |  |  | <input type="checkbox"/> <input type="checkbox"/> <input type="checkbox"/> <input type="checkbox"/> |  |  |
|   |  |  |   |  |  |   |  |  |
|   |  |  |   |  |  |   |  |  |

⑤

2

|  |    |    |       |
|--|----|----|-------|
|  |    |    |       |
|  | 2  | 30 |       |
|  | 1  |    | 30 40 |
|  | 0  | 5  |       |
|  | 30 |    |       |
|  | 30 | 2  |       |

3

60

4

2

100

20%

80%

1

1

|       |    |  |    |    |
|-------|----|--|----|----|
|       |    |  |    |    |
| (20 ) | 5  |  | 2  | 0  |
|       |    |  | 3  |    |
|       | 5  |  | 2  |    |
|       |    |  | 3  |    |
|       | 10 |  | 5  |    |
|       |    |  | 5  |    |
| (80 ) | 20 |  | 15 | 5  |
|       |    |  |    | 15 |
|       | 20 |  | 1  |    |
|       |    |  |    | 15 |
|       | 15 |  |    |    |
|       | 10 |  | 10 |    |

3.

1-3

(1) 任务描述: 2010 8 12

500                      500                      160                      15

8   15                      2010   8   16                      2010

0.4 /

- ①
  - ②
  - ③
- 10

|   |   |   |   |   |   |   |  |
|---|---|---|---|---|---|---|--|
|   |   |   |   |   |   |   |  |
|   |   |   |   |   |   |   |  |
|   |   |   |   |   |   |   |  |
| * | * | * | * | * | * | * |  |
|   |   |   |   |   |   |   |  |
|   |   |   |   |   |   |   |  |
|   |   |   |   |   |   |   |  |
| * | * |   | * |   | * |   |  |
|   |   |   |   |   |   |   |  |
|   |   |   |   |   |   |   |  |
|   |   |   |   |   |   |   |  |

④

15

⑤

20

2

|    |    |       |
|----|----|-------|
|    |    |       |
|    | 2  | 30    |
|    | 1  | 30 40 |
| 0  | 5  |       |
|    | 30 |       |
| 30 | 2  |       |

3

60

4

2

100

20%

80%

1

1

|       |    |  |   |   |
|-------|----|--|---|---|
|       |    |  |   |   |
| (20 ) | 5  |  | 2 |   |
|       |    |  | 3 |   |
|       | 5  |  |   | 2 |
|       |    |  | 3 |   |
|       | 10 |  |   | 5 |
|       |    |  | 5 |   |

Handwritten characters and symbols including a stylized 'F', a symbol resembling 'K', a symbol resembling 'P', and a symbol resembling 'B'.

|    |  |    |  |    |    |  |
|----|--|----|--|----|----|--|
|    |  | 15 |  | 10 |    |  |
|    |  |    |  | 5  |    |  |
|    |  |    |  |    | 5  |  |
| 80 |  | 15 |  |    |    |  |
|    |  | 20 |  |    |    |  |
|    |  | 10 |  |    | 10 |  |

Stylized handwritten character resembling a cursive 'S'.

Stylized handwritten characters including a large 'O' with a dot and a symbol resembling a double quote.

Stylized handwritten symbol resembling a double quote.

Stylized handwritten characters including a large 'V' and a symbol resembling a cursive 'S'.

|  |  |  |      |       |
|--|--|--|------|-------|
|  |  |  |      | 17.04 |
|  |  |  |      | 5     |
|  |  |  | 4    | 8     |
|  |  |  | 1920 | /     |
|  |  |  |      | 923   |
|  |  |  | 48   | /     |
|  |  |  |      | 2000  |
|  |  |  |      | 320   |
|  |  |  |      | 2000  |
|  |  |  |      | 500   |
|  |  |  |      | 800   |
|  |  |  |      | 200   |
|  |  |  |      |       |
|  |  |  |      | 1000  |
|  |  |  | 8    |       |

②

15

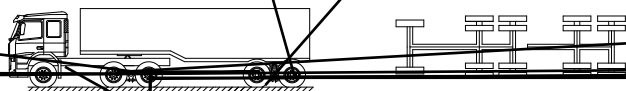

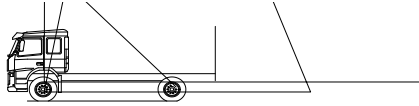

|       |    |  |     |       |
|-------|----|--|-----|-------|
| (20 ) | 5  |  | 2   |       |
|       | 5  |  | 3   | 2     |
|       | 10 |  | 3   | 5     |
|       |    |  |     | 0     |
|       | 15 |  | 5   | 10    |
|       | 20 |  | 1.5 | 2 2.5 |
|       | 15 |  | 3   |       |
|       | 15 |  | 15  |       |
|       | 15 |  | 15  |       |

5. 1-5

(1) 任务描述:

1



|  |  |    |
|--|--|----|
|  |  |    |
|  |  | 35 |
|  |  | 20 |
|  |  | 20 |

K 1011150008

64

|  |  |    |
|--|--|----|
|  |  |    |
|  |  | 35 |
|  |  | 20 |
|  |  | 10 |

DD1011150012

102

|  |  |    |
|--|--|----|
|  |  |    |
|  |  | 30 |
|  |  | 35 |
|  |  | 30 |

2

3

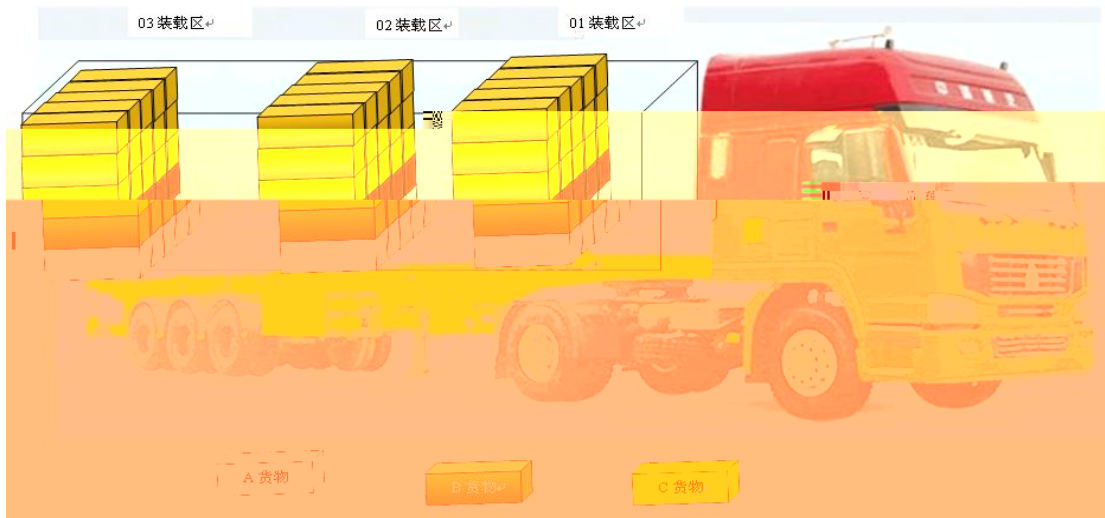

①

01

02

03

A

B

C

20  
 ② A B A  
 20 0.03<sup>3</sup> B 10  
 0.02<sup>3</sup> 10 20<sup>3</sup>  
 90% A B  
 100% 20  
 ③ 10  
 ④ 10  
 ⑤ 10

2

|    |    |       |
|----|----|-------|
|    |    |       |
|    | 2  | 30    |
|    | 1  | 30 40 |
| 0  | 5  |       |
|    | 30 |       |
| 30 | 2  |       |

3

60

4

2 100  
 20% 80%  
 1  
 1

|       |   |   |   |
|-------|---|---|---|
|       |   |   |   |
| (20 ) | 5 |   | 2 |
|       |   | 3 |   |

|       |  |    |  |    |    |
|-------|--|----|--|----|----|
|       |  | 5  |  |    | 2  |
|       |  |    |  | 3  |    |
|       |  | 10 |  |    | 5  |
|       |  |    |  | 5  |    |
|       |  |    |  |    | 0  |
|       |  | 20 |  | 10 | 10 |
|       |  |    |  | 10 |    |
|       |  | 20 |  | 15 | 5  |
|       |  |    |  |    |    |
|       |  | 15 |  | 2  | 15 |
| (80 ) |  |    |  | 15 |    |
|       |  | 15 |  | 10 | 5  |
|       |  |    |  | 5  |    |
|       |  | 10 |  |    | 5  |
|       |  |    |  |    | 5  |

6. 1-6

(1) 任务描述

D

2015 9

5,600

9,600

5

400 / , 130 70 30

5000

666

①

②

③

**D**

|   |  |  |   |  |  |   |  |  |  |
|---|--|--|---|--|--|---|--|--|--|
|   |  |  |   |  |  |   |  |  |  |
|   |  |  |   |  |  |   |  |  |  |
|   |  |  |   |  |  |   |  |  |  |
|   |  |  |   |  |  |   |  |  |  |
|   |  |  |   |  |  |   |  |  |  |
| <input type="checkbox"/> <input type="checkbox"/> |  |  | <input type="checkbox"/> <input type="checkbox"/> |  |  |   |  |  |  |
| <input type="checkbox"/> <input type="checkbox"/> |  |  |   |  |  |   |  |  |  |
|   |  |  |   |  |  | <input type="checkbox"/> <input type="checkbox"/> <input type="checkbox"/> <input type="checkbox"/> |  |  |  |
|   |  |  |   |  |  |   |  |  |  |
|   |  |  |   |  |  |   |  |  |  |

④

|   |  |  |  |
|---|--|--|--|
|   |  |  |  |
|  |  |  |  |
|  |  |  |  |
|  |  |  |  |

⑤

**2**

|  |    |       |  |
|--|----|-------|--|
|  |    |       |  |
|  | 2  | 30    |  |
|  | 1  | 30 40 |  |
|  | 5  | 0     |  |
|  | 30 |       |  |
|  | 30 | 2     |  |

**3**

**4**

|       |   |   |   |
|-------|---|---|---|
|       |   |   |   |
| (20 ) | 5 |   | 2 |
|       |   | 3 |   |



①  
②

15

10

|  |  |  |  |
|--|--|--|--|
|  |  |  |  |
|  |  |  |  |
|  |  |  |  |

③

15

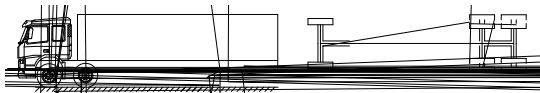

⑤

10000

4

3000

15000

20

2

|    |    |       |
|----|----|-------|
|    |    |       |
|    | 2  | 30    |
|    | 1  | 30 40 |
| 0  | 5  |       |
|    | 30 |       |
| 30 | 2  |       |

3

60

4

2

100

20%

80%

1

1

|       |    |  |   |
|-------|----|--|---|
|       |    |  |   |
| (20 ) | 5  |  | 2 |
|       |    |  | 3 |
|       | 5  |  | 2 |
|       |    |  | 3 |
|       | 10 |  |   |



|       |  |    |           |   |
|-------|--|----|-----------|---|
|       |  |    | 5         | 0 |
|       |  |    | 5         |   |
| (80 ) |  | 15 | 10<br>5   |   |
|       |  | 15 | 2 15      |   |
|       |  | 20 | 10<br>10  |   |
|       |  | 20 | 15<br>5   |   |
|       |  | 10 | 1.5<br>10 |   |

8. 1-8

(1) 任务描述

26 60  
556 6 6  
1 14.6 / 2 0.0704 /

①

20

②

15

③

10

④

,

15

⑤

20

2

|  |         |  |
|--|---------|--|
|  |         |  |
|  | 2 30    |  |
|  | 1 30 40 |  |

|  |    |   |  |
|--|----|---|--|
|  | 0  | 5 |  |
|  | 30 |   |  |
|  | 30 | 2 |  |

3

60

4

2

100

20%

80%

1

1

|       |    |  |    |   |
|-------|----|--|----|---|
|       |    |  |    |   |
| (20 ) | 5  |  | 2  | 0 |
|       |    |  | 3  |   |
|       | 5  |  | 2  |   |
|       |    |  | 3  |   |
|       | 10 |  | 5  |   |
| (80 ) | 20 |  | 15 |   |
|       |    |  | 5  |   |
|       | 15 |  | 10 |   |
|       |    |  | 5  |   |

|  |  |    |  |  |    |  |
|--|--|----|--|--|----|--|
|  |  | 10 |  |  | 10 |  |
|  |  | 15 |  |  | 5  |  |
|  |  | 20 |  |  | 10 |  |
|  |  |    |  |  | 5  |  |

9. 1-9

(1) 任务描述

( ) ( )

|  |  |   |     |  |  |  |
|--|--|---|-----|--|--|--|
|  |  |   |     |  |  |  |
|  |  | ) | ( ) |  |  |  |
|  |  |   |     |  |  |  |

( )  
 ( )  
 ( )  
 ( )  
 ( )

|  |  |  |
|--|--|--|
|  |  |  |
|  |  |  |
|  |  |  |
|  |  |  |
|  |  |  |
|  |  |  |
|  |  |  |
|  |  |  |
|  |  |  |

①

|     |  |  |  |  |  |
|-----|--|--|--|--|--|
| ( ) |  |  |  |  |  |
|     |  |  |  |  |  |
|     |  |  |  |  |  |
|     |  |  |  |  |  |
|     |  |  |  |  |  |
|     |  |  |  |  |  |
|     |  |  |  |  |  |
|     |  |  |  |  |  |
|     |  |  |  |  |  |



|   |         |
|---|---------|
| Sailing Schedule from : Shenzhen,Shenzhen,Guangdong,China   |         |
| To : Los Angeles,Los Angeles,CA,United States               |         |
| Origin City : Shenzhen,Shenzhen,Guangdong,China             | CY/DOOR |
| Destination City : Los Angeles,Los Angeles,CA,United States | CY/DOOR |

| 序列号 | 航线   | 船名                | 航次     | 截关时间             | 装货港     | 预计离港时间     | 实际离港时间 | 卸货港         |
|-----|------|-------------------|--------|------------------|---------|------------|--------|-------------|
| 1   | YPSW | YM UNISON         | 59E    | 2016-04-22 17:00 | Yantian | 2016-04-25 |        | Los Angeles |
| 2   | SEA  | NORTHERN JAVELIN  | 002E   | 2016-04-23 12:00 | Yantian | 2016-04-27 |        | Long Beach  |
| 3   | AAS2 | CMA CGM LIBRA     | 095TXE | 2016-04-25 16:00 | Yantian | 2016-04-28 |        | Long Beach  |
| 4   | YPSW | YM UBIQUITY       | 22E    | 2016-04-29 17:00 | Yantian | 2016-05-02 |        | Los Angeles |
| 5   | SEA  | C SCL PUSAN       | 117E   | 2016-04-30 12:00 | Yantian | 2016-05-04 |        | Long Beach  |
| 6   | AAS2 | CMA CGM COLUMBA   | 097TXE | 2016-05-02 16:00 | Yantian | 2016-05-05 |        | Long Beach  |
| 7   | SEA  | COSCO NINGBO      | 069W   | 2016-05-06 11:00 | Yantian | 2016-05-08 |        | Long Beach  |
| 8   | YPSW | YM JIREBY         | 50E    | 2016-05-06 17:00 | Yantian | 2016-05-09 |        | Los Angeles |
| 9   | SEA  | COSCO EXCELLENCE  | 027E   | 2016-05-07 12:00 | Yantian | 2016-05-11 |        | Long Beach  |
| 10  | AAS2 | CMA CGM CENTAURUS | 099TXE | 2016-05-09 16:00 | Yantian | 2016-05-12 |        | Long Beach  |
| 11  | YPSW | YM MASCULINITY    | 32E    | 2016-05-13 17:00 | Yantian | 2016-05-16 |        | Los Angeles |
| 12  | SEA  | HONG KONG BRIDGE  | 039E   | 2016-05-14 12:00 | Yantian | 2016-05-18 |        | Long Beach  |
| 13  | AAS2 | CMA CGM THALASSA  | 101TXE | 2016-05-16 16:00 | Yantian | 2016-05-19 |        | Long Beach  |

③

| 干货箱   |        |       |      |           |       |              |      |      |
|---|--------|-------|------|-----------|-------|--------------|------|------|
|  | 箱体内部尺寸 |       |      | 箱体内容积及载重量 |       | 箱门开度尺寸       |      |      |
|   | L      | W     | H    | Cu        | P     | W            | H    |      |
|   | 20'    | 5898  | 2352 | 2393      | 33.2  | 21740/28230# | 2340 | 2280 |
|   | 40'    | 12032 | 2352 | 2393      | 67.7  | 26630        | 2340 | 2280 |
| HC  | 12032  | 2352  | 2698 | 76.3      | 26520 | 2340         | 2585 |      |

| 冷藏箱   |        |       |      |           |       |              |
|---|--------|-------|------|-----------|-------|--------------|
|  | 箱体内部尺寸 |       |      | 箱体内容积及载重量 |       |              |
|   | L      | W     | H    | Cu        | P     |              |
|   | 20'    | 5444  | 2284 | 2267      | 28.5  | 21135/27160# |
|   | 40'    | 11583 | 2284 | 2250      | 58.7  | 26580        |
| HC  | 11583  | 2284  | 2550 | 67.9      | 26380 |              |

| 开顶箱  |        |       |      |           |      |       |
|--|--------|-------|------|-----------|------|-------|
|  | 箱体内部尺寸 |       |      | 箱体内容积及载重量 |      |       |
|  | L      | W     | H    | Cu        | P    |       |
|  | 20'    | 5900  | 2330 | 2337      | 32.6 | 21740 |
|  | 40'    | 12025 | 2330 | 2337      | 65.8 | 26410 |

④

⑤

## (2) 实施条件

|  |    |              |
|--|----|--------------|
|  |    |              |
|  | 2  | 30           |
|  |    | 1 30 40<br>0 |
|  | 5  |              |
|  | 30 |              |
|  | 30 | 2            |

## (3) 考核时量

#### (4) 评分细则

1

|       |    |  |  |   |   |
|-------|----|--|--|---|---|
|       |    |  |  |   |   |
| (20 ) | 5  |  |  | 2 | 3 |
|       | 5  |  |  | 2 | 3 |
|       | 10 |  |  | 5 | 0 |
|       |    |  |  | 1 |   |
|       |    |  |  |   |   |
|       |    |  |  |   |   |
|       |    |  |  |   |   |



|  |  |  |  |  |  |
|--|--|--|--|--|--|
|  |  |  |  |  |  |
|  |  |  |  |  |  |

10.

1-10

(1) 任务描述

|  |  |    |  |    |  |  |
|--|--|----|--|----|--|--|
|  |  | EK |  | LA |  |  |
|  |  |    |  |    |  |  |
|  |  |    |  |    |  |  |

①

|  |  |                          |                          |
|--|--|--------------------------|--------------------------|
|  |  |                          |                          |
|  |  |                          |                          |
|  |  |                          |                          |
|  |  | <input type="checkbox"/> | <input type="checkbox"/> |
|  |  | <input type="checkbox"/> | <input type="checkbox"/> |
|  |  |                          |                          |

|   |  |   |  |  |
|---|--|---|--|--|
|   |  |   |  |  |
|   |  |   |  |  |
|   |  |   |  |  |
| □ |  | □ |  |  |
| □ |  | □ |  |  |
|   |  |   |  |  |
|   |  |   |  |  |

②

③



④

⑤

(2) 实施条件

|  |    |              |
|--|----|--------------|
|  |    |              |
|  | 2  | 30           |
|  | 5  | 1 30 60<br>0 |
|  |    | 30           |
|  | 30 | 2            |

**(3) 考核时量**

**(4) 评分细则**

**1**

|       |    |  |   |   |
|-------|----|--|---|---|
|       |    |  |   |   |
| (20 ) | 5  |  | 2 | 3 |
|       | 5  |  | 2 | 3 |
|       | 10 |  | 5 | 5 |

|  |  |  |  |   |   |
|--|--|--|--|---|---|
|  |  |  |  |   | 0 |
|  |  |  |  | 2 |   |
|  |  |  |  |   |   |
|  |  |  |  |   |   |
|  |  |  |  |   |   |
|  |  |  |  |   |   |

## 二、仓储与配送作业组织与管理模块

1. 2-1

1

50

40

( ) 20

1

|    |               |     |      |
|----|---------------|-----|------|
|    | /             |     |      |
| 1  | 6956511900725 |     | 177  |
| 2  | 6939261900108 |     | 980  |
| 3  | 6932010062065 |     | 17   |
| 4  | 6932010061976 |     | 130  |
| 5  | 6932010061969 |     | 72   |
| 6  | 6932010061952 |     | 42   |
| 7  | 6932010061945 |     | 456  |
| 8  | 6932010061938 |     | 14   |
| 9  | 6932010061921 |     | 104  |
| 10 | 6932010061914 |     | 90   |
| 11 | 6932010061907 | 1+2 | 381  |
| 12 | 6932010061891 |     | 1018 |
| 13 | 6932010061884 |     | 890  |
| 14 | 6932010061877 |     | 81   |
| 15 | 6932010061860 |     | 1416 |
| 16 | 6932010061853 |     | 100  |
| 17 | 6932010061846 |     | 300  |

ABC

|  |   |        |         |          |
|--|---|--------|---------|----------|
|  | % | 0 A 15 | 15 B 45 | 45 C 100 |
|  | % | 0 A 65 | 65 B 90 | 90 C 100 |

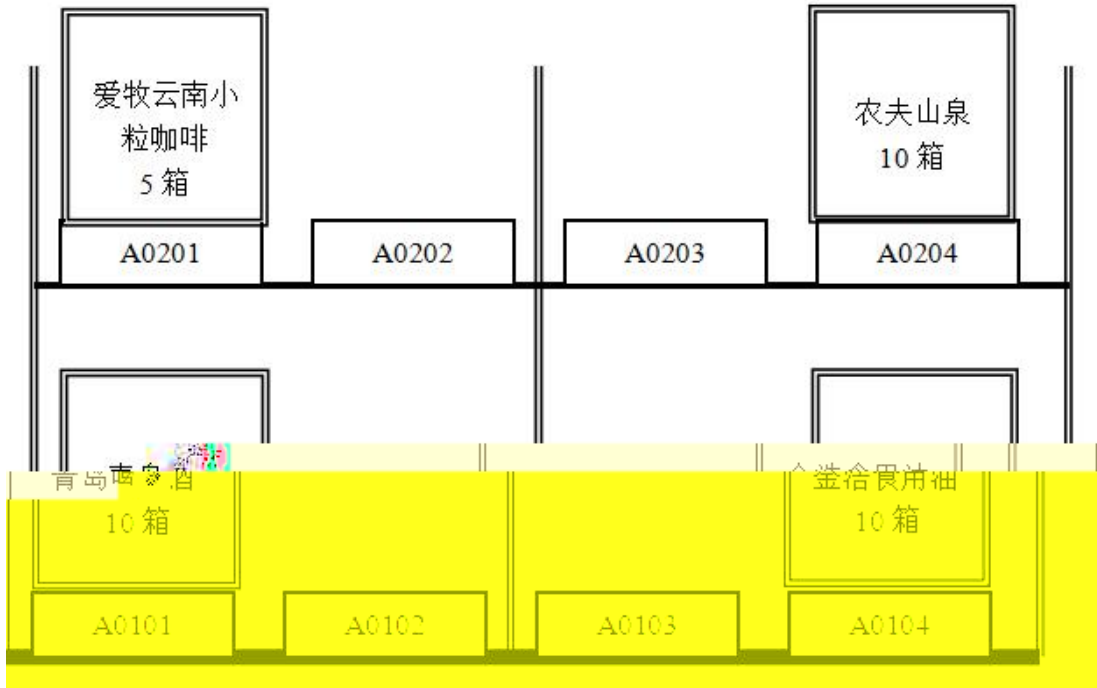

# 产品运输单

| 1 |     |  |  |  |  |  |  |
|---|-----|--|--|--|--|--|--|
| 2 | ( ) |  |  |  |  |  |  |
|   |     |  |  |  |  |  |  |
|   |     |  |  |  |  |  |  |

①

ABC

②

③

④

⑤

⑥

F

F

⑦

⑧

F

F







2.

2-2

1

40

40

20

1

|  |   |  |       |
|--|---|--|-------|
|  | / |  |       |
|  |   |  | 1456  |
|  |   |  | 400   |
|  |   |  | 2008  |
|  |   |  | 1233  |
|  |   |  | 476   |
|  |   |  | 65    |
|  |   |  | 32    |
|  |   |  | 3724  |
|  |   |  | 12433 |
|  |   |  | 98    |
|  |   |  | 3124  |
|  |   |  | 1345  |
|  |   |  | 300   |
|  |   |  | 2080  |
|  |   |  | 488   |
|  |   |  | 986   |
|  |   |  | 2036  |
|  |   |  | 520   |
|  |   |  | 20    |

|  |  |     |       |
|--|--|-----|-------|
|  |  |     | 13000 |
|  |  |     | 87    |
|  |  |     | 54    |
|  |  |     | 10000 |
|  |  |     | 488   |
|  |  | 1+2 | 212   |
|  |  |     | 768   |
|  |  |     | 21    |
|  |  |     | 8945  |
|  |  |     | 1178  |
|  |  |     | 4024  |
|  |  |     | 576   |
|  |  |     | 656   |
|  |  |     | 1421  |

ABC

|  |   |        |         |          |
|--|---|--------|---------|----------|
|  | % | 0 A 15 | 15 B 45 | 45 C 100 |
|  | % | 0 A 60 | 60 B 90 | 90 C 100 |



## 产品运输单

---

| 1 |  |  |  |  |  |  |  |
|---|--|--|--|--|--|--|--|
| 2 |  |  |  |  |  |  |  |
|   |  |  |  |  |  |  |  |
|   |  |  |  |  |  |  |  |

- ① ABC
- ②
- ③
- ④
- ⑤
- ⑥ F F
- ⑦
- ⑧ F F

2

|  |               |       |
|--|---------------|-------|
|  |               |       |
|  |               |       |
|  | 2   2   2   2 | 1   1 |







3. 2-3

1

20

40

30

1

|    |               |     |       |
|----|---------------|-----|-------|
|    | /             |     |       |
| 1  | 6932010061884 |     | 5684  |
| 2  | 6932010061839 |     | 2624  |
| 3  | 6932010061891 |     | 2304  |
| 4  | 6932010061945 |     | 16096 |
| 5  | 6932010061808 |     | 4712  |
| 6  | 6932010061921 |     | 35780 |
| 7  | 6956511900725 |     | 84    |
| 8  | 6932010061952 |     | 3072  |
| 9  | 6917878001982 | 1+2 | 848   |
| 10 | 6932010061815 |     | 1952  |
| 11 | 6932010061907 |     | 40000 |
| 12 | 6918010061360 |     | 216   |
| 13 | 6932010061969 |     | 348   |
| 14 | 6921168509256 |     | 52000 |
| 15 | 6932010061938 |     | 80    |
| 16 | 6931528109163 |     | 2080  |
| 17 | 6932010061846 |     | 8144  |
| 18 | 6920855052068 |     | 3944  |
| 19 | 6932010061853 |     | 1952  |

|    |               |  |       |
|----|---------------|--|-------|
| 20 | 6901521103123 |  | 8320  |
| 21 | 6903148042441 |  | 1200  |
| 22 | 6917878007441 |  | 5380  |
| 23 | 6920855784129 |  | 12496 |
| 24 | 6932010061860 |  | 392   |
| 25 | 4891599338393 |  | 5824  |
| 26 | 6918163010887 |  | 14896 |
| 27 | 6932010061877 |  | 128   |
| 28 | 6939261900108 |  | 260   |
| 29 | 6920907800173 |  | 1904  |
| 30 | 6932010062065 |  | 4932  |
| 31 | 6932010061976 |  | 8032  |
| 32 | 6901668054852 |  | 1600  |
| 33 | 6932010061822 |  | 49732 |

ABC

|  |   |        |         |          |
|--|---|--------|---------|----------|
|  | % | 0 A 15 | 15 B 45 | 45 C 100 |
|  | % | 0 A 65 | 65 B 90 | 90 C 100 |

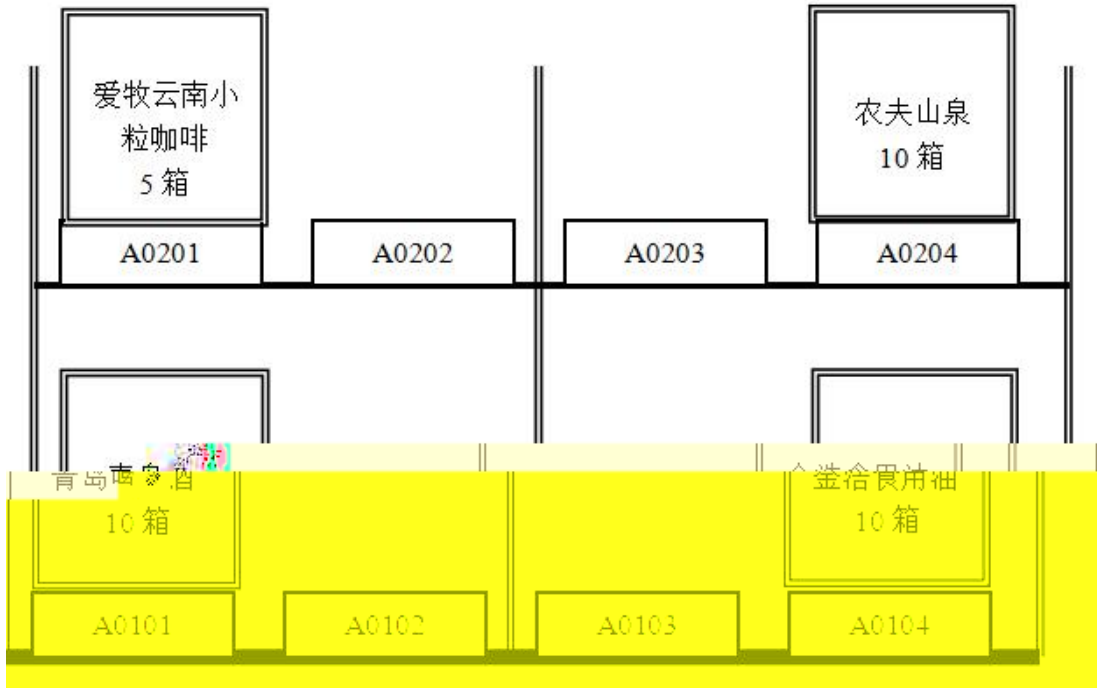



运输单

| 1 |  |  |  |  |  |  |  |
|---|--|--|--|--|--|--|--|
| 2 |  |  |  |  |  |  |  |
| 3 |  |  |  |  |  |  |  |
|   |  |  |  |  |  |  |  |

①

ABC

②

③

④

⑤

⑥

F

F

⑦

⑧

F

F





4. 2-4

1

40

30

30

1

|    | /             |  |      |
|----|---------------|--|------|
| 1  | 6939261900108 |  | 54   |
| 2  | 6932010062065 |  | 421  |
| 3  | 6932010061976 |  | 432  |
| 4  | 6932010061976 |  | 6000 |
| 5  | 6932010061969 |  | 65   |
| 6  | 6932010061952 |  | 245  |
| 7  | 6932010061945 |  | 765  |
| 8  | 6932010061907 |  | 298  |
| 9  | 6932010061891 |  | 199  |
| 10 | 6932010061884 |  | 412  |
| 11 | 6932010061860 |  | 76   |
| 12 | 6932010061853 |  | 164  |
| 13 | 6932010061846 |  | 533  |
| 14 | 6932010061839 |  | 231  |
| 15 | 6932010061822 |  | 1994 |
| 16 | 6932010061815 |  | 176  |
| 17 | 6932010061808 |  | 267  |
| 18 | 6931528109163 |  | 187  |
| 19 | 6921168509256 |  | 2345 |

|    |               |     |      |
|----|---------------|-----|------|
| 20 | 6920907800173 |     | 132  |
| 21 | 6920855784129 |     | 632  |
| 22 | 6920855052068 |     | 254  |
| 23 | 6918163010887 |     | 654  |
| 24 | 6918010061360 |     | 43   |
| 25 | 6917878007441 |     | 345  |
| 26 | 6917878001982 | 1+2 | 87   |
| 27 | 6903148042441 |     | 90   |
| 28 | 6901668054852 |     | 123  |
| 29 | 6901521103123 |     | 589  |
| 30 | 4891599338393 |     | 2003 |

ABC

|  |   |        |         |          |
|--|---|--------|---------|----------|
|  | % | 0 A 15 | 15 B 40 | 40 C 100 |
|  | % | 0 A 65 | 65 B 85 | 85 C 100 |



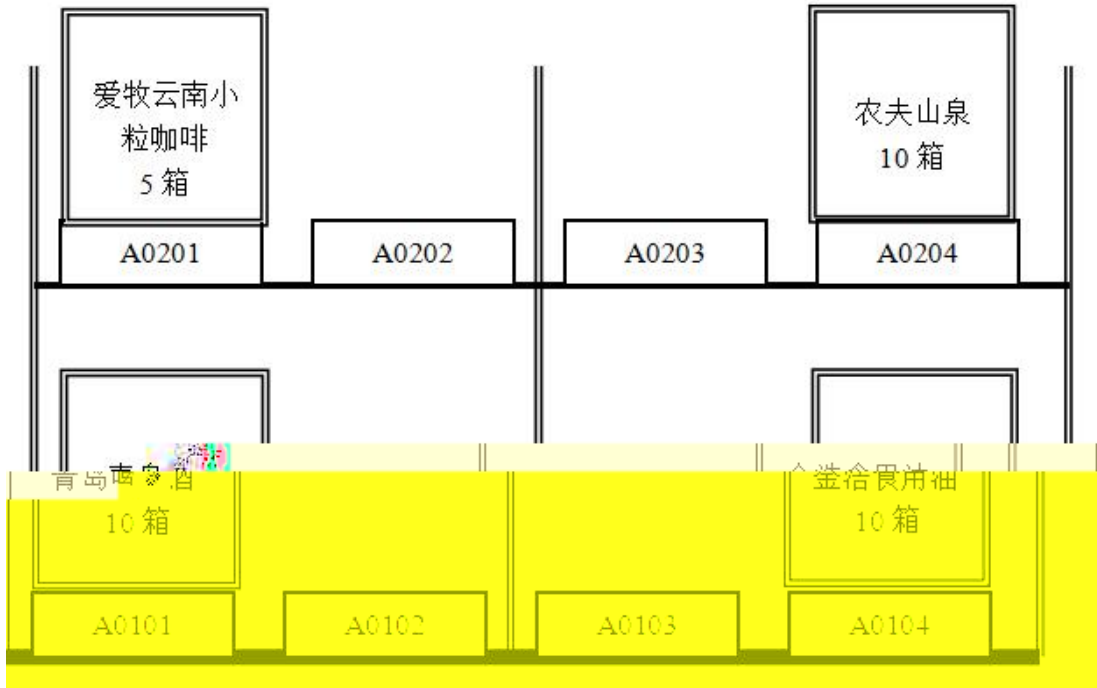

## 产品运输单

---

| 1 |  |  |  |  |  |  |  |
|---|--|--|--|--|--|--|--|
| 2 |  |  |  |  |  |  |  |
| 3 |  |  |  |  |  |  |  |
|   |  |  |  |  |  |  |  |

- ① ABC
- ②
- ③
- ④
- ⑤
- ⑥ F F
- ⑦
- ⑧ F F

2

|  | 2   2   2   2 | 1   1 |
|--|---------------|-------|

|  |      |      |     |    |   |
|--|------|------|-----|----|---|
|  | 2    | 1    | 1   | 1  |   |
|  | 1    | 1    | 1   | F  | 2 |
|  | 2    |      | 1   | 1  |   |
|  | 1200 | 1000 | 144 | 10 |   |
|  |      |      |     |    |   |

3

120

4



5. 2-5

1

40

40

20

1

|    | /             |     |      |
|----|---------------|-----|------|
| 1  | 6932010061884 |     | 825  |
| 2  | 6932010061839 |     | 463  |
| 3  | 6932010061891 |     | 399  |
| 4  | 6932010061945 |     | 1531 |
| 5  | 6932010061976 |     | 865  |
| 6  | 6932010061808 |     | 535  |
| 7  | 6932010061952 |     | 491  |
| 8  | 6917878001982 | 1+2 | 175  |
| 9  | 6932010061815 |     | 353  |
| 10 | 6918010061360 |     | 87   |
| 11 | 6932010061969 |     | 131  |
| 12 | 6921168509256 |     | 3989 |
| 13 | 6931528109163 |     | 375  |
| 14 | 6932010061846 |     | 1067 |
| 15 | 6920855052068 |     | 509  |
| 16 | 6932010061853 |     | 329  |
| 17 | 6901521103123 |     | 1179 |
| 18 | 6903148042441 |     | 181  |

|    |               |  |       |
|----|---------------|--|-------|
| 19 | 6917878007441 |  | 691   |
| 20 | 6920855784129 |  | 1265  |
| 21 | 6932010061860 |  | 153   |
| 22 | 4891599338393 |  | 4007  |
| 23 | 6918163010887 |  | 1309  |
| 24 | 6939261900108 |  | 109   |
| 25 | 6920907800173 |  | 265   |
| 26 | 6932010062065 |  | 12001 |
| 27 | 6932010061907 |  | 597   |
| 28 | 6932010061976 |  | 4691  |
| 29 | 6901668054852 |  | 247   |
| 30 | 6932010061822 |  | 843   |

ABC

|  |   |        |         |          |
|--|---|--------|---------|----------|
|  | % | 0 A 15 | 15 B 40 | 40 C 100 |
|  | % | 0 A 65 | 65 B 85 | 85 C 100 |

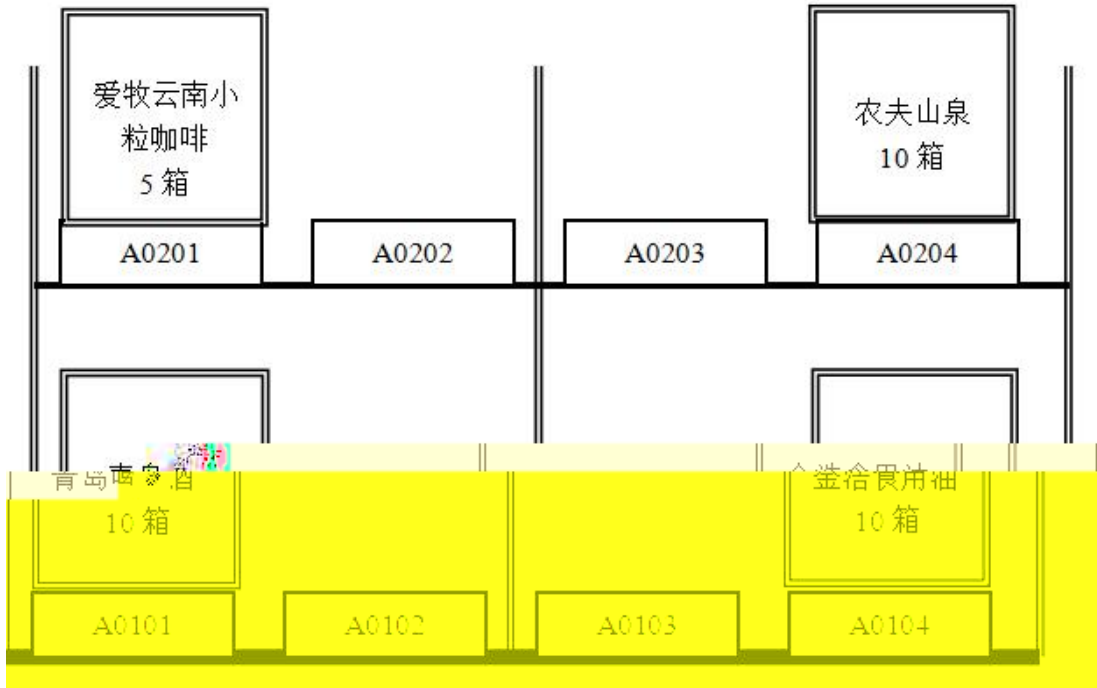

产品运输单

| 1 | ( ) |  |  |  |  |  |  |
|---|-----|--|--|--|--|--|--|
| 2 |     |  |  |  |  |  |  |
|   |     |  |  |  |  |  |  |
|   |     |  |  |  |  |  |  |

2

①

ABC

②

③

④

⑤

4000 Q4i D S \$





|  |  |  |  |  |  |
|--|--|--|--|--|--|
|  |  |  |  |  |  |
|  |  |  |  |  |  |
|  |  |  |  |  |  |
|  |  |  |  |  |  |
|  |  |  |  |  |  |
|  |  |  |  |  |  |
|  |  |  |  |  |  |
|  |  |  |  |  |  |
|  |  |  |  |  |  |
|  |  |  |  |  |  |

6.

2-6

1

.

50

40

( ) 20

O Oe T a

|    |                           |     |
|----|---------------------------|-----|
|    | /                         |     |
| 1  | 6932010061938             | 41  |
| 2  | 6932010062065             | 50  |
| 3  | 6932010061952             | 125 |
| 4  | 6901668054852             | 188 |
| 5  | 6920855052068             | 209 |
| 6  | 6932010061969             | 215 |
| 7  | 6917878001982             | 221 |
| 8  | 6932010061877             | 242 |
| 9  | <del>02020</del> 10061914 | 269 |
| 10 | 6903148042441             | 290 |
| 11 | 6932010061853             | 299 |
| 12 | 6932010061921             | 311 |
| 13 | 6918010061360             | 329 |
| 14 | 6932010061976             | 389 |
| 15 | 6956511900725             | 530 |
| 16 | 6917878007441             | 599 |
| 17 | 6920855784129             |     |

6

# B

|    |               |  |       |
|----|---------------|--|-------|
| 32 | 6921168509256 |  | 6631  |
| 33 | 6920907800173 |  | 3001  |
| 34 | 6918163010887 |  | 9766  |
| 35 | 6902774003017 |  | 16429 |

ABC

%

0 AB



## 产品运输单







7. 2-7

1

40

40

20

1

|    |               |  |      |
|----|---------------|--|------|
|    | /             |  |      |
| 1  | 6939261900108 |  | 51   |
| 2  | 6932010062065 |  | 5997 |
| 3  | 6932010061976 |  | 2342 |
| 4  | 6932010061976 |  | 429  |
| 5  | 6932010061969 |  | 62   |
| 6  | 6932010061952 |  | 242  |
| 7  | 6932010061945 |  | 762  |
| 8  | 6932010061907 |  | 1991 |
| 9  | 6932010061907 |  | 295  |
| 10 | 6932010061891 |  | 196  |
| 11 | 6932010061884 |  | 409  |
| 12 | 6932010061860 |  | 73   |
| 13 | 6932010061853 |  | 161  |
| 14 | 6932010061846 |  | 530  |
| 15 | 6932010061839 |  | 228  |
| 16 | 6932010061822 |  | 418  |
| 17 | 6932010061815 |  | 173  |
| 18 | 6932010061808 |  | 264  |
| 19 | 6931528109163 |  | 184  |

|    |               |     |      |
|----|---------------|-----|------|
| 20 | 6920907800173 |     | 129  |
| 21 | 6920855784129 |     | 629  |
| 22 | 6920855052068 |     | 251  |
| 23 | 6918163010887 |     | 651  |
| 24 | 6918010061360 |     | 40   |
| 25 | 6917878007441 |     | 342  |
| 26 | 6917878001982 | 1+2 | 84   |
| 27 | 6903148042441 |     | 87   |
| 28 | 6901668054852 |     | 120  |
| 29 | 6901521103123 |     | 586  |
| 30 | 4891599338393 |     | 2000 |

ABC

|  |   |        |         |          |
|--|---|--------|---------|----------|
|  | % | 0 A 15 | 15 B 40 | 40 C 100 |
|  | % | 0 A 65 | 65 B 85 | 85 C 100 |









8.

2-8

1

20

40

30

1

|    |               |     |      |
|----|---------------|-----|------|
|    | /             |     |      |
| 1  | 6956511900725 |     | 344  |
| 2  | 6939261900108 |     | 1950 |
| 3  | 6932010062065 |     | 24   |
| 4  | 6932010061976 |     | 250  |
| 5  | 6932010061969 |     | 134  |
| 6  | 6932010061952 |     | 74   |
| 7  | 6932010061945 |     | 902  |
| 8  | 6932010061938 |     | 18   |
| 9  | 6932010061921 |     | 198  |
| 10 | 6932010061914 |     | 170  |
| 11 | 6932010061907 |     | 6500 |
| 12 | 6932010061907 | 1+2 | 752  |
| 13 | 6932010061891 |     | 2026 |
| 14 | 6932010061884 |     | 1770 |
| 15 | 6932010061877 |     | 152  |
| 16 | 6932010061860 |     | 2822 |
| 17 | 6932010061853 |     | 190  |
| 18 | 6932010061846 |     | 590  |
| 19 | 6932010061839 |     | 1350 |

|    |               |  |       |
|----|---------------|--|-------|
| 20 | 6932010061822 |  | 6190  |
| 21 | 6932010061822 |  | 530   |
| 22 | 6932010061815 |  | 510   |
| 23 | 6932010061808 |  | 862   |
| 24 | 6931528109163 |  | 990   |
| 25 | 6921168509256 |  | 4410  |
| 26 | 6920907800173 |  | 1990  |
| 27 | 6920855784129 |  | 470   |
| 28 | 6920855052068 |  | 130   |
| 29 | 6918010061360 |  | 210   |
| 30 | 6917878007441 |  | 390   |
| 31 | 6917878001982 |  | 138   |
| 32 | 6903148042441 |  | 184   |
| 33 | 6902774003017 |  | 10942 |
| 34 | 6901668054852 |  | 116   |
| 35 | 6901521103123 |  | 1400  |

ABC

|  |   |        |         |          |
|--|---|--------|---------|----------|
|  | % | 0 A 15 | 15 B 45 | 45 C 100 |
|  | % | 0 A 65 | 65 B 90 | 90 C 100 |



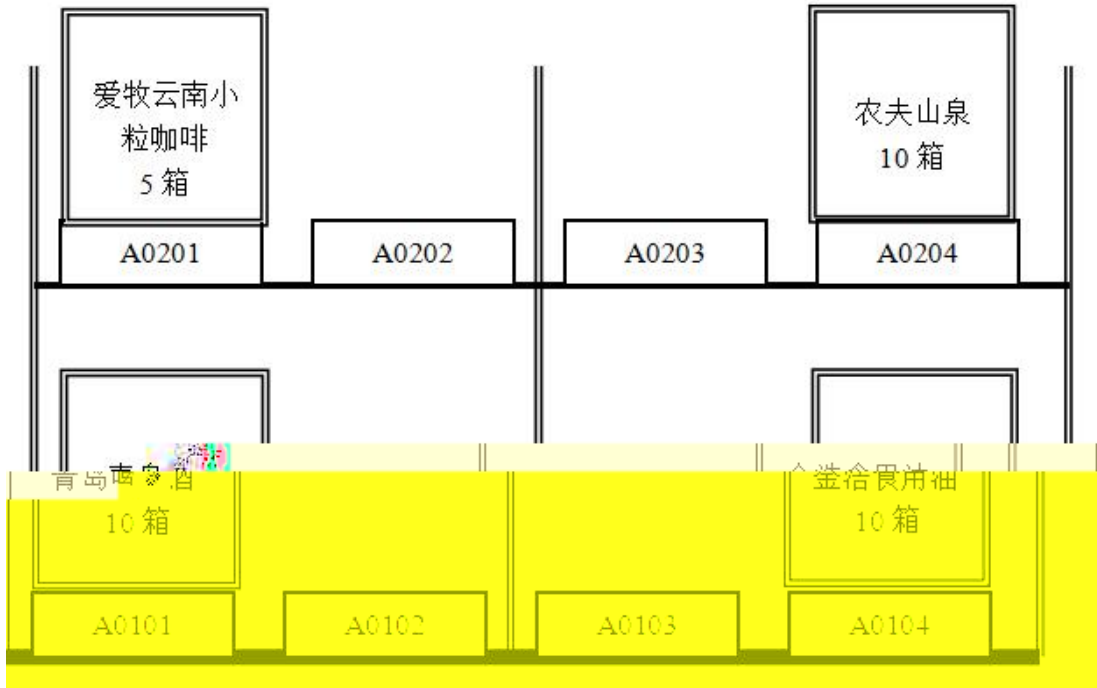







9. 2-9

1

40

30

30

1

|    |               |     |      |
|----|---------------|-----|------|
|    | /             |     |      |
| 1  | 4891599338393 |     | 7564 |
| 2  | 6901521103123 |     | 2000 |
| 3  | 6901668054852 |     | 284  |
| 4  | 6903148042441 |     | 280  |
| 5  | 6917878001982 | 1+2 | 256  |
| 6  | 6917878007441 |     | 729  |
| 7  | 6918010061360 |     | 54   |
| 8  | 6918163010887 |     | 2300 |
| 9  | 6920855052068 |     | 421  |
| 10 | 6920855784129 |     | 2100 |
| 11 | 6920907800173 |     | 321  |
| 12 | 6921168509256 |     | 8000 |
| 13 | 6931528109163 |     | 375  |
| 14 | 6932010061808 |     | 422  |
| 15 | 6932010061815 |     | 367  |
| 16 | 6932010061822 |     | 954  |
| 17 | 6932010061839 |     | 400  |
| 18 | 6932010061846 |     | 1987 |
| 19 | 6932010061853 |     | 345  |

|    |               |  |      |
|----|---------------|--|------|
| 20 | 6932010061860 |  | 210  |
| 21 | 6932010061877 |  | 45   |
| 22 | 6932010061884 |  | 897  |
| 23 | 6932010061891 |  | 389  |
| 24 | 6932010061907 |  | 5321 |
| 25 | 6932010061921 |  | 1521 |
| 26 | 6932010061938 |  | 11   |
| 27 | 6932010061945 |  | 2345 |
| 28 | 6932010061952 |  | 411  |
| 29 | 6932010061969 |  | 204  |
| 30 | 6932010061976 |  | 5000 |
| 31 | 6932010062065 |  | 626  |
| 32 | 6939261900108 |  | 66   |
| 33 | 6956511900725 |  | 23   |

ABC

|  |   |        |         |          |
|--|---|--------|---------|----------|
|  | % | 0 A 15 | 15 B 45 | 45 C 100 |
|  | % | 0 A 60 | 60 B 90 | 90 C 100 |

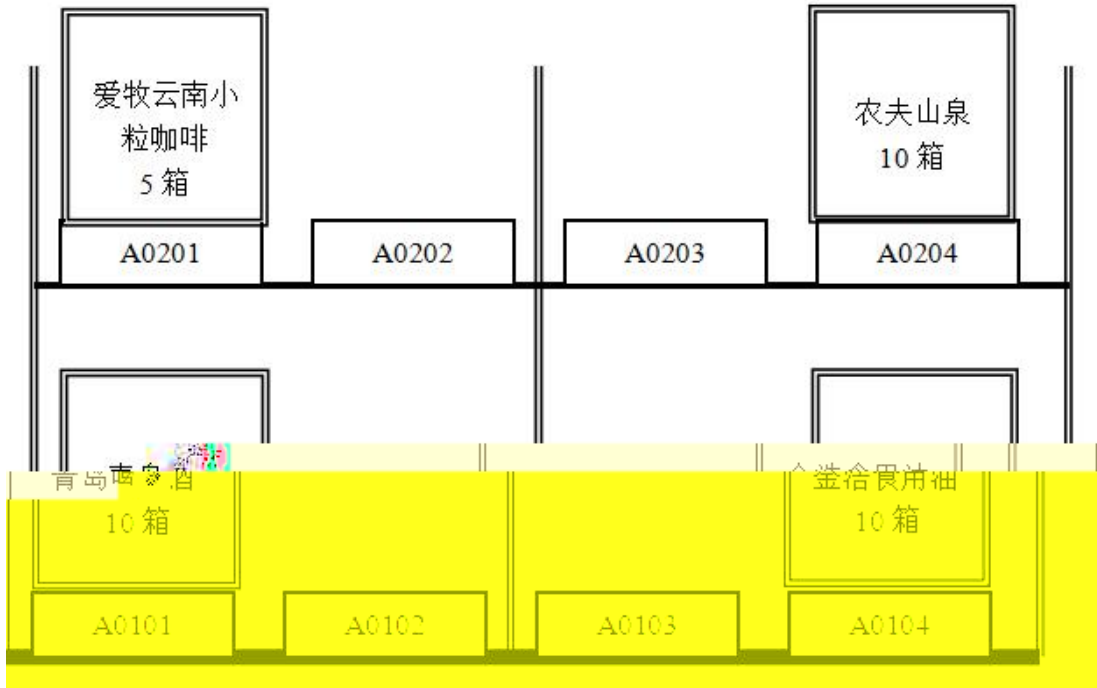









10.

2-10

1

40

40

20

1

|    | /             |  |       |
|----|---------------|--|-------|
| 1  | 6932010061822 |  | 2862  |
| 2  | 6901668054852 |  | 852   |
| 3  | 6932010061976 |  | 15000 |
| 4  | 6932010062065 |  | 1878  |
| 5  | 6920907800173 |  | 963   |
| 6  | 6939261900108 |  | 198   |
| 7  | 6932010061877 |  | 135   |
| 8  | 6918163010887 |  | 6900  |
| 9  | 4891599338393 |  | 22692 |
| 10 | 6932010061860 |  | 630   |
| 11 | 6920855784129 |  | 6300  |
| 12 | 6917878007441 |  | 2187  |
| 13 | 6903148042441 |  | 840   |
| 14 | 6901521103123 |  | 6000  |
| 15 | 6932010061853 |  | 1035  |
| 16 | 6920855052068 |  | 1263  |
| 17 | 6932010061846 |  | 5961  |

|    |               |              |       |
|----|---------------|--------------|-------|
| 18 | 6931528109163 |              | 1125  |
| 19 | 6932010061938 |              | 33    |
| 20 | 6921168509256 |              | 24000 |
| 21 | 6932010061969 |              | 612   |
| 22 | 6918010061360 |              | 162   |
| 23 | 6932010061907 |              | 15963 |
| 24 | 6932010061815 |              | 1101  |
| 25 | 6917878001982 | 1+2          | 768   |
| 26 | 6932010061952 |              | 1233  |
| 27 | 6956511900725 |              | 69    |
| 28 | 6932010061921 | 620300619281 |       |



## 产品运输单

---

| 1 | ( ) |  |  |  |  |  |  |
|---|-----|--|--|--|--|--|--|
| 2 |     |  |  |  |  |  |  |
|   |     |  |  |  |  |  |  |
|   |     |  |  |  |  |  |  |

- ① ABC
- ②
- ③
- ④
- ⑤
- ⑥ F F
- ⑦
- ⑧ F F

2

|  |         |     |
|--|---------|-----|
|  |         |     |
|  |         |     |
|  | 2 2 2 2 | 1 1 |







11.

2-11

1

①

---

|   |  |     | ( ) |   |  |
|---|--|-----|-----|---|--|
| 1 |  |     | 2   | 3 |  |
| 2 |  |     | 298 | 4 |  |
| 3 |  |     | 5   | 2 |  |
|   |  | --- | --- |   |  |

---

|   |  |     | ( ) |   |  |
|---|--|-----|-----|---|--|
| 1 |  |     | 2   | 2 |  |
| 2 |  |     | 298 | 5 |  |
|   |  | --- | --- |   |  |

---

|   |  |     | ( ) |   |  |
|---|--|-----|-----|---|--|
| 1 |  |     | 2   | 2 |  |
| 2 |  |     | 298 | 6 |  |
| 3 |  |     | 5   | 1 |  |
|   |  | --- | --- |   |  |

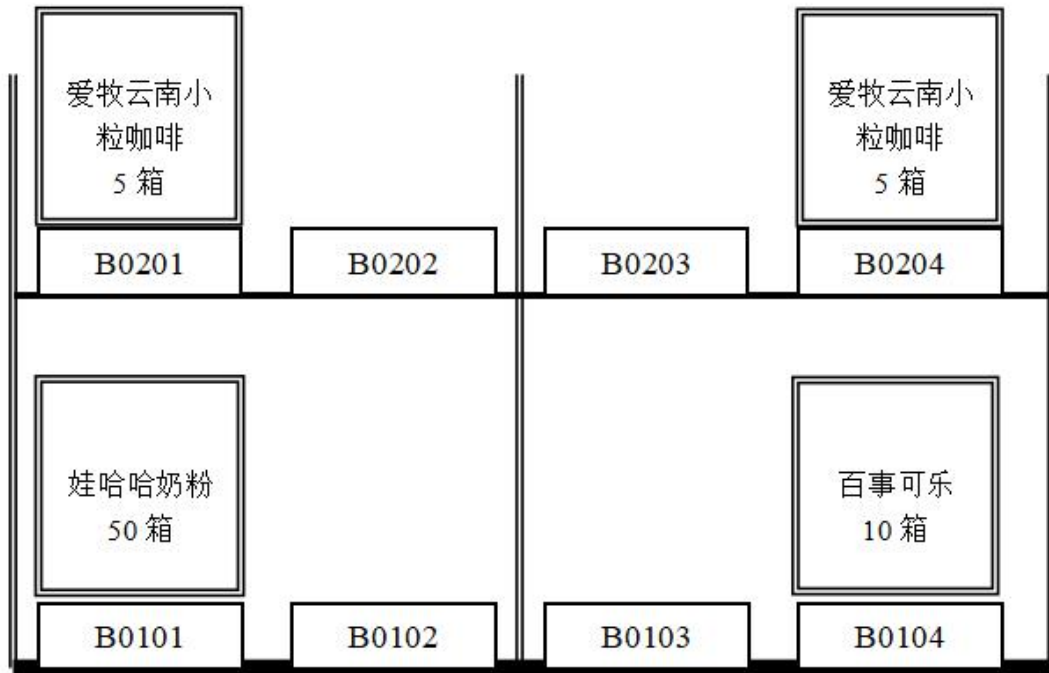

•

•

F

•

•

•

①

②

|  |               |    |    |  |
|--|---------------|----|----|--|
|  | 1200 1000 144 | 10 | 10 |  |
|  |               | 2  | 1  |  |

3

120

4

|    |  |  |   |    |   |
|----|--|--|---|----|---|
|    |  |  |   | 3  |   |
|    |  |  |   |    | 2 |
|    |  |  |   | 6  | 2 |
|    |  |  | M | 3  | 2 |
|    |  |  |   | 3  | 2 |
| 30 |  |  |   | 10 | 5 |
|    |  |  |   |    | 5 |
|    |  |  |   | 6  | 4 |
|    |  |  |   |    |   |

12. 2-12

1

D

D

---

|   |  |  | ( ) |   |  |
|---|--|--|-----|---|--|
| 1 |  |  | 2   | 3 |  |
| 2 |  |  | 298 | 5 |  |
| 3 |  |  | 3   | 1 |  |

|  |  |     |     |  |  |
|--|--|-----|-----|--|--|
|  |  | --- | --- |  |  |
|--|--|-----|-----|--|--|

---

|   |  |     | ( ) |   |  |
|---|--|-----|-----|---|--|
| 1 |  |     | 2   | 3 |  |
| 2 |  |     | 298 | 6 |  |
| 3 |  |     | 3   | 2 |  |
|   |  | --- | --- |   |  |

---

|   |  |     | ( ) |   |  |
|---|--|-----|-----|---|--|
| 1 |  |     | 2   | 4 |  |
| 2 |  |     | 298 | 1 |  |
| 3 |  |     | 3   | 4 |  |
|   |  | --- | --- |   |  |



· M

·  
·  
·  
·  
·  
·  
·

F

①



②

2



|  |                     |  |
|--|---------------------|--|
|  |                     |  |
|  | 1                   |  |
|  | 2 2 2 2 1 1         |  |
|  | 2 1 1 1 F 2         |  |
|  | 2 1 1               |  |
|  | 1200 1000 144 10 10 |  |
|  | 2 1                 |  |

3

120

4

|  |  |   |       |
|--|--|---|-------|
|  |  |   |       |
|  |  |   | 2     |
|  |  |   | 1 2   |
|  |  |   | 1 2 2 |
|  |  |   | 1 2   |
|  |  |   | 2 2   |
|  |  |   | 1 2   |
|  |  |   | 5     |
|  |  | M | 1 2   |
|  |  |   | 2 1   |
|  |  | M | 4 1   |



|   |  |     | ( ) |   |  |
|---|--|-----|-----|---|--|
| 1 |  |     | 60  | 2 |  |
| 2 |  |     | 298 | 2 |  |
| 3 |  |     | 3   | 1 |  |
|   |  | --- | --- |   |  |

---

|   |  |     | ( ) |   |  |
|---|--|-----|-----|---|--|
| 1 |  |     | 298 | 3 |  |
| 2 |  |     | 3   | 1 |  |
|   |  | --- | --- |   |  |

---

|   |  |     | ( ) |   |  |
|---|--|-----|-----|---|--|
| 1 |  |     | 60  | 3 |  |
| 2 |  |     | 298 | 3 |  |
| 3 |  |     | 3   | 1 |  |
|   |  | --- | --- |   |  |

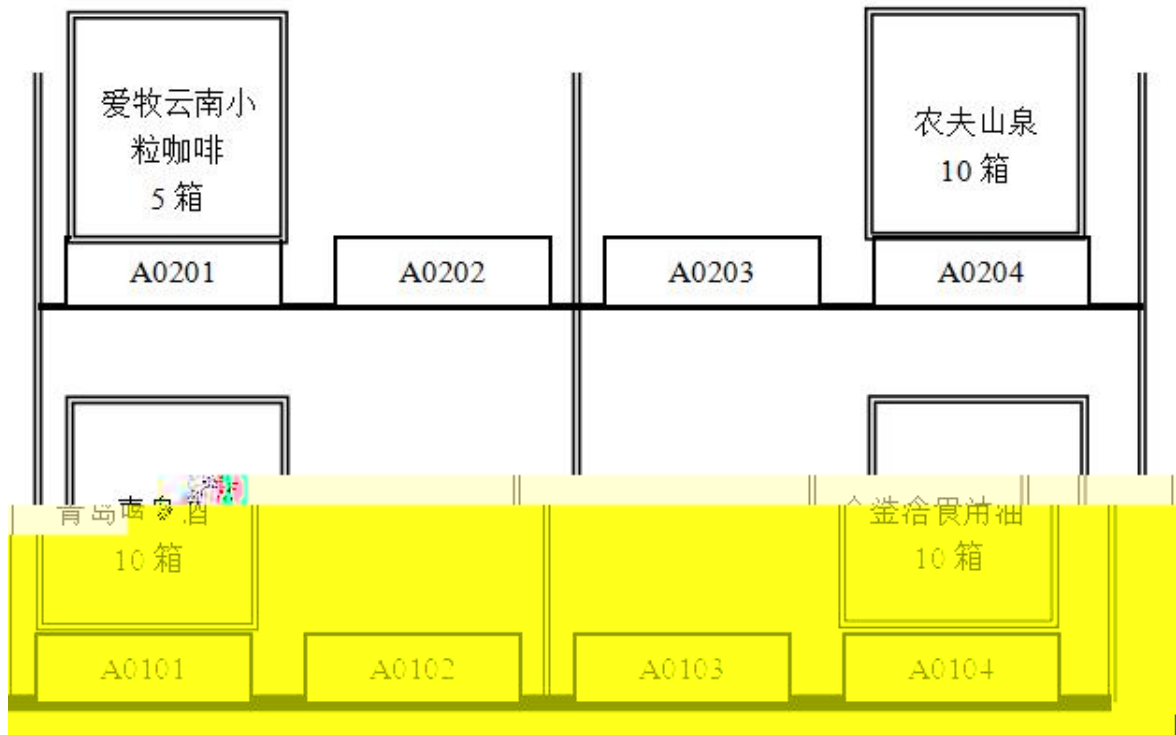

· M

·

·

·

·

·

·

F

①



②

2

|  |      |      |     |   |    |   |    |   |
|--|------|------|-----|---|----|---|----|---|
|  |      |      |     |   |    |   |    |   |
|  | 1    |      |     |   |    |   |    |   |
|  | 2    | 2    | 2   | 2 |    | 1 |    | 1 |
|  |      |      | 2   |   | 1  |   | 1  | 1 |
|  |      | 1    |     | 1 | 1  | F | 2  |   |
|  | 2    |      |     | 1 |    | 1 |    |   |
|  | 1200 | 1000 | 144 |   | 10 |   | 10 |   |
|  |      |      | 2   |   | 1  |   |    |   |

3

120

4

|  |  |  |  |   |   |
|--|--|--|--|---|---|
|  |  |  |  |   |   |
|  |  |  |  | 2 |   |
|  |  |  |  | 1 | 2 |
|  |  |  |  | 1 |   |
|  |  |  |  | 2 | 2 |
|  |  |  |  |   | 1 |
|  |  |  |  | 2 |   |
|  |  |  |  |   | 2 |
|  |  |  |  | 2 |   |
|  |  |  |  | 2 |   |
|  |  |  |  | 1 |   |
|  |  |  |  |   | 5 |

|    |  |  |       |    |   |
|----|--|--|-------|----|---|
| 50 |  |  | M     | 1  | 2 |
|    |  |  |       | 2  | 1 |
|    |  |  | M     |    | 4 |
|    |  |  | M     |    | 1 |
|    |  |  |       |    | 2 |
| 30 |  |  | ( F ) | 2  | 2 |
|    |  |  | ( F ) | 3  | 3 |
|    |  |  |       | 3  | F |
|    |  |  |       | 3  |   |
|    |  |  |       | 6  | 2 |
|    |  |  |       | 2  |   |
|    |  |  | M     | 2  | 2 |
|    |  |  |       | 3  | 3 |
|    |  |  |       | 3  | 2 |
|    |  |  |       | 5  | 5 |
|    |  |  |       | 10 | 5 |
|    |  |  |       |    | 4 |
|    |  |  |       |    | 3 |
|    |  |  |       |    |   |

14.

2-14

1

1

---

|   |  |     | ( ) |   |  |
|---|--|-----|-----|---|--|
| 1 |  |     | 60  | 2 |  |
| 2 |  |     | 298 | 3 |  |
| 3 |  |     | 3   | 3 |  |
|   |  | --- | --- |   |  |

---

|   |  |     | ( ) |   |  |
|---|--|-----|-----|---|--|
| 1 |  |     | 60  | 2 |  |
| 2 |  |     | 298 | 3 |  |
|   |  | --- | --- |   |  |

---

|   |  |     | ( ) |   |  |
|---|--|-----|-----|---|--|
| 1 |  |     | 60  | 1 |  |
| 2 |  |     | 298 | 4 |  |
| 3 |  |     | 3   | 2 |  |
|   |  | --- | --- |   |  |



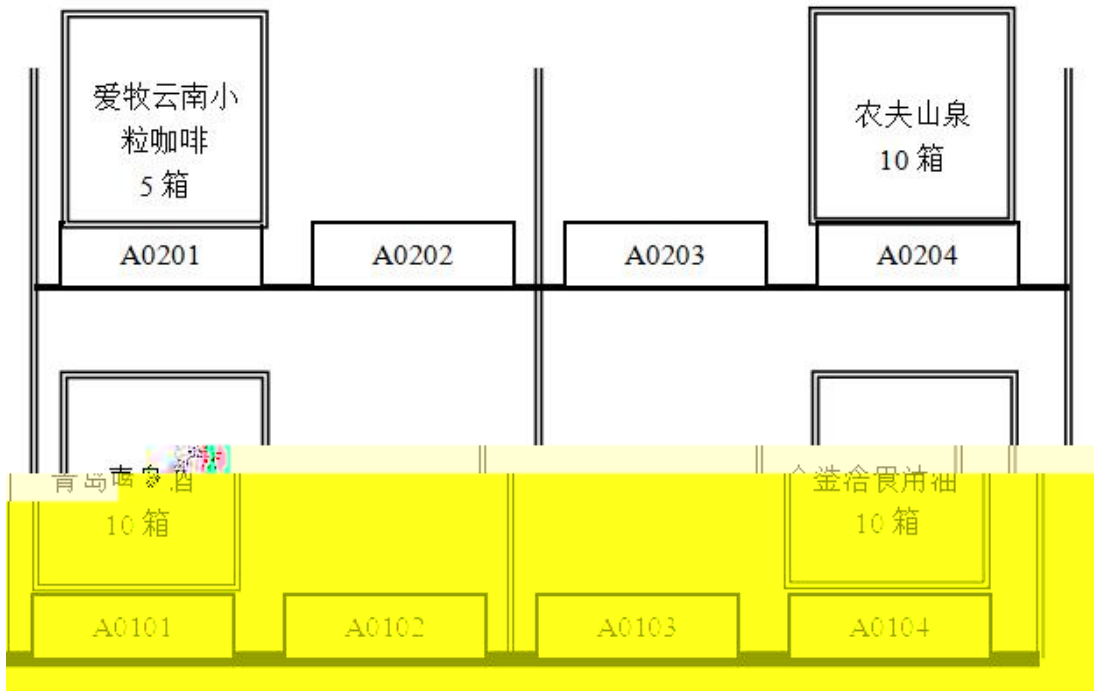

. M

.

.

.

F





|    |  |  |       |                   |
|----|--|--|-------|-------------------|
|    |  |  | ( F ) | 1 3<br>3 F 1<br>3 |
|    |  |  |       | 2<br>2<br>6 2     |
|    |  |  | M     | 2<br>3 3<br>3 2   |
| 30 |  |  |       | 5<br>10 5         |
|    |  |  |       | 5<br>5            |
|    |  |  |       |                   |

15. 2-15

1

1

---

|   |  |  | ( ) |   |  |
|---|--|--|-----|---|--|
| 1 |  |  | 60  | 3 |  |
| 2 |  |  | 298 | 2 |  |
| 3 |  |  | 3   | 2 |  |

|  |  |     |     |  |  |
|--|--|-----|-----|--|--|
|  |  | --- | --- |  |  |
|--|--|-----|-----|--|--|

---

|   |  |     | ( ) |   |  |
|---|--|-----|-----|---|--|
| 1 |  |     | 60  | 2 |  |
| 2 |  |     | 298 | 3 |  |
|   |  | --- | --- |   |  |

---

|   |  |     | ( ) |   |  |
|---|--|-----|-----|---|--|
| 1 |  |     | 298 | 4 |  |
| 2 |  |     | 3   | 2 |  |
|   |  | --- | --- |   |  |

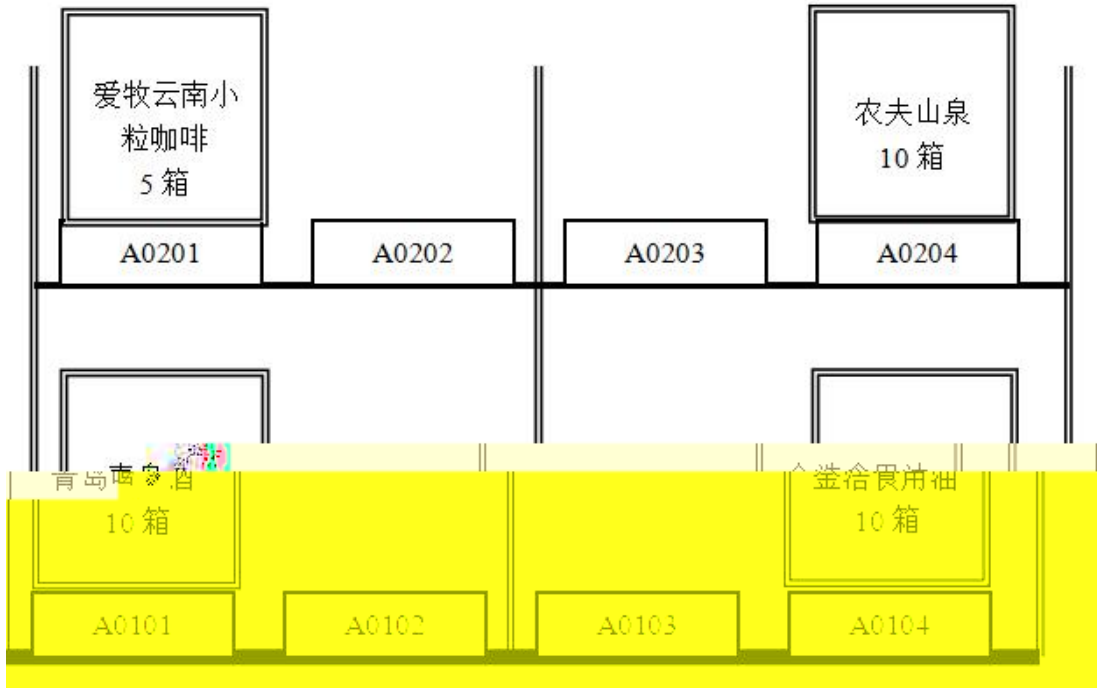

· M

·  
·  
·  
·  
·  
·  
·

F

①



②

|  |                     |  |
|--|---------------------|--|
|  |                     |  |
|  | 1                   |  |
|  | 2 2 2 2 1 1         |  |
|  | 2 1 1 1 F 2 1       |  |
|  | 2 1 1               |  |
|  | 1200 1000 144 10 10 |  |
|  | 2 1                 |  |

3

120

4

|  |  |   |     |
|--|--|---|-----|
|  |  |   |     |
|  |  |   | 2   |
|  |  |   | 1 2 |
|  |  |   | 1 2 |
|  |  |   | 2 2 |
|  |  |   | 1 2 |
|  |  |   | 2 2 |
|  |  |   | 1 2 |
|  |  |   | 5   |
|  |  | M | 1 2 |
|  |  |   | 2 1 |



|    |  |  |       |    |   |   |   |   |
|----|--|--|-------|----|---|---|---|---|
| 50 |  |  | M     |    | 4 |   |   |   |
|    |  |  | M     |    | 1 |   |   |   |
|    |  |  | ( F ) |    | 2 |   | 2 |   |
|    |  |  | ( F ) |    | 3 | 1 | 3 | 1 |
|    |  |  |       | 3  |   | F |   |   |
|    |  |  |       |    |   |   | 2 |   |
|    |  |  |       | 6  |   | 2 |   |   |
|    |  |  |       |    |   | 2 |   |   |
|    |  |  | M     |    | 3 |   |   |   |
|    |  |  |       | 3  |   |   | 2 |   |
| 30 |  |  |       |    | 5 |   |   |   |
|    |  |  |       | 10 |   | 5 |   |   |
|    |  |  |       |    | 5 |   | 3 |   |
|    |  |  |       |    |   |   | 2 |   |
|    |  |  |       |    |   |   |   |   |

16.

2-16

1

|  |               |  |                |               |                  |               |
|--|---------------|--|----------------|---------------|------------------|---------------|
|  | 2009081602    |  |                |               |                  |               |
|  |               |  |                |               |                  |               |
|  |               |  | 6-201          |               |                  | 0731-63415468 |
|  |               |  | 58966326770051 |               |                  |               |
|  | 77            |  |                | 230022        |                  |               |
|  | 0731-69912861 |  |                | 0731-63415468 |                  | 0731-69912880 |
|  | @136.         |  |                | 58413516      | <b>M N</b>       | @ .           |
|  |               |  |                |               | 1576784563131450 |               |
|  |               |  |                |               | 100              |               |
|  | 15            |  |                |               |                  | 13.75         |
|  |               |  |                |               | B                |               |

|  |               |  |                     |             |  |               |
|--|---------------|--|---------------------|-------------|--|---------------|
|  | 2003020157    |  |                     |             |  |               |
|  |               |  |                     |             |  |               |
|  |               |  | 18                  |             |  | 0731-67918998 |
|  |               |  | 1202431325876<br>76 |             |  |               |
|  | 56            |  |                     | 23005<br>1  |  |               |
|  | 0731-63287689 |  | 0731-66858957       |             |  | 0731-63287688 |
|  | @ .           |  | 698654678           | M N         |  | @ .           |
|  |               |  |                     | 87965687975 |  |               |
|  |               |  |                     | 1200        |  |               |
|  | 200           |  |                     |             |  | 199.99        |
|  |               |  |                     | A           |  |               |

|  |               |  |                 |               |     |               |
|--|---------------|--|-----------------|---------------|-----|---------------|
|  | 2008160902    |  |                 |               |     |               |
|  |               |  |                 |               |     |               |
|  |               |  | 3-803           |               |     | 0731-67655865 |
|  |               |  | 120108758377888 |               |     |               |
|  | 653           |  |                 | 230016        |     |               |
|  | 0731-63876590 |  |                 | 0731-68657973 |     | 0731-63876591 |
|  | @ .           |  |                 | 2115667907    | M N | @ .           |
|  |               |  |                 | 5356899765569 |     |               |
|  |               |  |                 | 3600          |     |               |
|  | 180           |  |                 |               |     | 179.8         |
|  |               |  |                 | A             |     |               |

|   |  |  | ( ) |     |     |  |
|---|--|--|-----|-----|-----|--|
| 1 |  |  | 4.5 | 100 | 450 |  |
| 2 |  |  | 2   | 200 | 400 |  |
| 3 |  |  | 3   | 300 | 900 |  |
| 4 |  |  | 3   | 200 | 600 |  |
|   |  |  | --- | --- |     |  |

|   |  |  | ( ) |     |      |  |
|---|--|--|-----|-----|------|--|
| 1 |  |  | 4.5 | 300 | 1350 |  |
| 2 |  |  | 2   | 400 | 800  |  |
| 3 |  |  | 3   | 500 | 1500 |  |
| 4 |  |  | 3   | 200 | 600  |  |
|   |  |  |     |     |      |  |

|   |  |  | ( ) |     |      |  |
|---|--|--|-----|-----|------|--|
| 1 |  |  | 5   | 200 | 1000 |  |
| 2 |  |  | 2   | 300 | 600  |  |
| 3 |  |  | 4.5 | 100 | 450  |  |
| 4 |  |  | 3   | 100 | 300  |  |
|   |  |  |     |     |      |  |

①

|  |  |  |  |
|--|--|--|--|
|  |  |  |  |
|  |  |  |  |
|  |  |  |  |
|  |  |  |  |
|  |  |  |  |
|  |  |  |  |
|  |  |  |  |
|  |  |  |  |
|  |  |  |  |

②

|  |  |
|--|--|
|  |  |
|  |  |
|  |  |

|  |  |
|--|--|
|  |  |
|  |  |

|   |  |  | ( ) |   |  |
|---|--|--|-----|---|--|
| 1 |  |  | 5   | 2 |  |
| 2 |  |  | 2   | 3 |  |
| 3 |  |  | 4.5 | 3 |  |
| 4 |  |  | 3   | 1 |  |
|   |  |  |     |   |  |

- 
- 
- 

2

|  | 1       |       |
|--|---------|-------|
|  | 2 2 2 2 | 1 1   |
|  | 2       | 1 1 1 |

|  |      |      |     |   |    |    |
|--|------|------|-----|---|----|----|
|  | 1    | 1    | 1   | F | 2  |    |
|  | 2    |      | 1   |   | 1  |    |
|  | 1200 | 1000 | 144 |   | 10 | 10 |
|  |      |      | 2   |   | 1  |    |

3

120

4

|  |  |      |    |    |     |
|--|--|------|----|----|-----|
|  |  |      |    |    |     |
|  |  |      |    |    |     |
|  |  |      |    |    |     |
|  |  |      |    |    |     |
|  |  |      |    | 12 | 0.5 |
|  |  |      |    | 8  | 2   |
|  |  |      |    | 3  | 1   |
|  |  | M    |    | 1  | 10  |
|  |  |      |    |    | 3   |
|  |  |      |    | 2  |     |
|  |  |      |    | 4  | 1   |
|  |  | M    |    |    |     |
|  |  | (D ) |    |    | 2   |
|  |  |      | 16 |    | 2   |

|  |  |  |   |   |  |
|--|--|--|---|---|--|
|  |  |  |   | 2 |  |
|  |  |  |   | 4 |  |
|  |  |  |   | 4 |  |
|  |  |  | 2 |   |  |
|  |  |  |   |   |  |

17. 2-17

1

|  |               |  |                |        |               |
|--|---------------|--|----------------|--------|---------------|
|  | 2009081602    |  |                |        |               |
|  |               |  |                |        |               |
|  |               |  | 6-201          |        | 0731-63415468 |
|  |               |  | 58966326770051 |        |               |
|  | 77            |  |                | 230022 |               |
|  | 0731-69912861 |  | 0731-63415468  |        | 0731-69912880 |



|  |       |  |          |                  |       |  |
|--|-------|--|----------|------------------|-------|--|
|  | @136. |  | 58413516 | M N              | @ .   |  |
|  |       |  |          | 1576784563131450 |       |  |
|  |       |  |          | 100              |       |  |
|  | 15    |  |          |                  | 12.75 |  |
|  |       |  |          | B                |       |  |

|  |               |  |                 |             |               |
|--|---------------|--|-----------------|-------------|---------------|
|  | 2003042301    |  |                 |             |               |
|  |               |  |                 |             | H             |
|  |               |  | 7-301           |             | 0731-67535668 |
|  |               |  | 120109278662905 |             |               |
|  | 888           |  |                 | 230061      |               |
|  | 0731-67530866 |  | 0731-63520577   |             | 0731-67530866 |
|  | % @162.       |  | 663820355       | M N         | % @162.       |
|  |               |  |                 | 62839067352 |               |
|  |               |  |                 | 100         |               |
|  | 5             |  |                 |             | 4.9           |
|  |               |  |                 | B           |               |

|  |               |  |                 |               |     |               |
|--|---------------|--|-----------------|---------------|-----|---------------|
|  | 2008160902    |  |                 |               |     |               |
|  |               |  |                 |               |     |               |
|  |               |  | 3-803           |               |     | 0731-67655865 |
|  |               |  | 120108758377888 |               |     |               |
|  | 653           |  |                 | 230016        |     |               |
|  | 0731-63876590 |  |                 | 0731-68657973 |     | 0731-63876591 |
|  | @ .           |  |                 | 2115667907    | M N | @ .           |
|  |               |  |                 | 5356899765569 |     |               |
|  |               |  |                 | 3600          |     |               |
|  | 180           |  |                 |               |     | 178           |
|  |               |  |                 | A             |     |               |

|   |  |  | ( ) |     | ( ) |  |
|---|--|--|-----|-----|-----|--|
| 1 |  |  | 2   | 200 | 400 |  |
| 2 |  |  | 2   | 400 | 800 |  |
| 3 |  |  | 4.5 | 200 | 900 |  |
|   |  |  | --- |     |     |  |

|   |  |  | ( ) |     |      |  |
|---|--|--|-----|-----|------|--|
| 1 |  |  | 4.5 | 100 | 450  |  |
| 2 |  |  | 2   | 400 | 800  |  |
| 3 |  |  | 3   | 500 | 1500 |  |
| 4 |  |  | 3   | 200 | 600  |  |
|   |  |  |     |     |      |  |

|   |  |  | ( ) |     |      |  |
|---|--|--|-----|-----|------|--|
| 1 |  |  | 4.5 | 200 | 1000 |  |
| 2 |  |  | 2   | 300 | 600  |  |
| 3 |  |  | 3   | 100 | 450  |  |
| 4 |  |  | 3   | 100 | 300  |  |
|   |  |  |     |     |      |  |

①

|  |  |  |  |
|--|--|--|--|
|  |  |  |  |
|  |  |  |  |
|  |  |  |  |
|  |  |  |  |
|  |  |  |  |
|  |  |  |  |
|  |  |  |  |
|  |  |  |  |
|  |  |  |  |

②

|  |  |
|--|--|
|  |  |
|  |  |
|  |  |

|  |  |
|--|--|
|  |  |
|  |  |

|   |  |     | ( ) |   |   |  |
|---|--|-----|-----|---|---|--|
| 1 |  |     | 4.5 | 2 | 9 |  |
| 2 |  |     | 2   | 2 | 4 |  |
| 3 |  |     | 3   | 3 | 9 |  |
| 4 |  |     | 3   | 1 | 3 |  |
|   |  | --- | --- |   |   |  |

- 
- 
- 

2

|  | 1 |   |   |   |   |
|--|---|---|---|---|---|
|  | 2 | 2 | 2 | 2 | 1 |
|  |   |   | 2 |   | 1 |
|  |   |   | 2 | 1 | 1 |
|  |   |   | 2 | 1 | 1 |

|  |      |      |     |   |    |    |
|--|------|------|-----|---|----|----|
|  | 1    | 1    | 1   | F | 2  |    |
|  | 2    |      | 1   |   | 1  |    |
|  | 1200 | 1000 | 144 |   | 10 | 10 |
|  |      |      | 2   |   | 1  |    |

3

120

4

|  |  |      |    |    |     |
|--|--|------|----|----|-----|
|  |  |      |    |    |     |
|  |  |      |    |    |     |
|  |  |      |    |    |     |
|  |  |      |    |    |     |
|  |  |      |    | 12 | 0.5 |
|  |  |      |    | 8  | 2   |
|  |  |      |    | 3  | 1   |
|  |  | M    |    | 1  | 10  |
|  |  |      |    |    | 3   |
|  |  |      |    | 2  |     |
|  |  |      |    | 4  | 1   |
|  |  | M    |    |    |     |
|  |  | (D ) |    |    | 2   |
|  |  |      | 16 |    | 2   |

|  |  |  |   |   |  |
|--|--|--|---|---|--|
|  |  |  |   | 2 |  |
|  |  |  |   | 4 |  |
|  |  |  |   | 4 |  |
|  |  |  | 2 |   |  |
|  |  |  |   |   |  |

18. 2-18

1

|  |               |     |                 |        |               |
|--|---------------|-----|-----------------|--------|---------------|
|  | 2003042301    |     |                 |        |               |
|  |               |     |                 |        | H             |
|  |               |     | 7-301           |        | 0731-67535668 |
|  |               |     | 120109278662905 |        |               |
|  |               | 888 |                 | 230061 |               |
|  | 0731-67530866 |     | 0731-63520577   |        | 0731-67530866 |
|  | % @162.       |     | 663820355       | M N    | % @162.       |

|  |   |  |  |  |             |  |     |
|--|---|--|--|--|-------------|--|-----|
|  |   |  |  |  | 62839067352 |  |     |
|  |   |  |  |  | 100         |  |     |
|  | 6 |  |  |  |             |  | 4.9 |
|  |   |  |  |  | B           |  |     |

2003020157

1202

18

0731-67918998

|  |               |  |                 |               |     |               |
|--|---------------|--|-----------------|---------------|-----|---------------|
|  | 2008160902    |  |                 |               |     |               |
|  |               |  |                 |               |     |               |
|  |               |  | 3-803           |               |     | 0731-67655865 |
|  |               |  | 120108758377888 |               |     |               |
|  | 653           |  |                 | 230016        |     |               |
|  | 0731-63876590 |  |                 | 0731-68657973 |     | 0731-63876591 |
|  | @ .           |  |                 | 2115667907    | M N | @ .           |
|  |               |  |                 | 5356899765569 |     |               |
|  |               |  |                 | 3600          |     |               |
|  | 10            |  |                 |               |     | 9.8           |
|  |               |  |                 | A             |     |               |

|   |  |  | ( ) |     |     |  |
|---|--|--|-----|-----|-----|--|
| 1 |  |  | 4.5 | 200 | 900 |  |
| 2 |  |  | 2   | 100 | 200 |  |
| 3 |  |  | 3   | 200 | 600 |  |
|   |  |  | --- | --- |     |  |



|   |  |  | ( ) |     |      |  |
|---|--|--|-----|-----|------|--|
| 1 |  |  | 4.5 | 300 | 1350 |  |
| 2 |  |  | 2   | 300 | 600  |  |
| 3 |  |  | 3   | 300 | 900  |  |
| 4 |  |  | 3   | 500 | 1500 |  |
|   |  |  |     |     |      |  |

|   |  |  | ( ) |     |      |  |
|---|--|--|-----|-----|------|--|
| 1 |  |  | 5   | 100 | 1000 |  |
| 2 |  |  | 2   | 200 | 600  |  |
| 3 |  |  | 4.5 | 100 | 450  |  |
| 4 |  |  | 3   | 500 | 300  |  |
|   |  |  |     |     |      |  |

①

|  |  |  |  |
|--|--|--|--|
|  |  |  |  |
|  |  |  |  |
|  |  |  |  |
|  |  |  |  |
|  |  |  |  |
|  |  |  |  |
|  |  |  |  |
|  |  |  |  |
|  |  |  |  |

②

|  |  |
|--|--|
|  |  |
|  |  |
|  |  |

|  |  |
|--|--|
|  |  |
|  |  |

|   |  |  | ( ) |   |   |
|---|--|--|-----|---|---|
| 1 |  |  | 4.5 | 4 | 1 |
| 2 |  |  | 2   | 3 | 2 |
| 3 |  |  | 3   | 1 | 3 |
| 4 |  |  | 3   | 2 | 4 |
|   |  |  |     |   |   |

- 
- 
- 

2

|  | 1       |       |
|--|---------|-------|
|  | 2 2 2 2 | 1 1   |
|  | 2       | 1 1 1 |
|  | 1 1     | 1 F 2 |

|  |      |      |     |       |
|--|------|------|-----|-------|
|  | 2    | 1    | 1   |       |
|  | 1200 | 1000 | 144 | 10 10 |
|  |      | 2    | 1   |       |

3

120

4

|  |  |      |    |      |
|--|--|------|----|------|
|  |  |      |    |      |
|  |  |      |    |      |
|  |  |      |    |      |
|  |  |      | 12 | 0.5  |
|  |  |      | 8  | 2    |
|  |  |      | 3  | 1    |
|  |  | M    |    | 1 10 |
|  |  |      |    | 3    |
|  |  |      |    | 2    |
|  |  | M    | 4  | 1    |
|  |  | (D ) |    | 2    |
|  |  |      | 16 | 2    |
|  |  |      | 2  |      |

|  |  |  |  |   |  |
|--|--|--|--|---|--|
|  |  |  |  | 4 |  |
|  |  |  |  | 4 |  |
|  |  |  |  | 2 |  |
|  |  |  |  |   |  |

19.

2-19



|  |               |  |                 |             |               |
|--|---------------|--|-----------------|-------------|---------------|
|  | 2003042301    |  |                 |             |               |
|  |               |  |                 |             | H             |
|  |               |  | 7-301           |             | 0731-67535668 |
|  |               |  | 120109278662905 |             |               |
|  | 888           |  |                 | 230061      |               |
|  | 0731-67530866 |  | 0731-63520577   |             | 0731-67530866 |
|  | % @162.       |  | 663820355       | M N         | % @162.       |
|  |               |  |                 | 62839067352 |               |
|  |               |  |                 | 100         |               |
|  | 5             |  |                 |             | 4             |
|  |               |  |                 | B           |               |

|   |  |  |     |     |     |  |
|---|--|--|-----|-----|-----|--|
|   |  |  | ( ) |     |     |  |
| 1 |  |  | 4.5 | 100 | 450 |  |

|   |  |  |   |     |     |  |
|---|--|--|---|-----|-----|--|
| 2 |  |  | 2 | 100 | 200 |  |
| 3 |  |  | 3 | 100 | 300 |  |
| 4 |  |  | 3 | 100 | 300 |  |
|   |  |  |   |     |     |  |

|   |  |  | ( ) |     |      |  |
|---|--|--|-----|-----|------|--|
| 1 |  |  | 4.5 | 300 | 1350 |  |
| 2 |  |  | 2   | 300 | 600  |  |
| 3 |  |  | 3   | 600 | 1800 |  |
|   |  |  |     |     |      |  |

|   |  |  | ( ) |     |      |  |
|---|--|--|-----|-----|------|--|
| 1 |  |  | 5   | 300 | 1500 |  |
| 2 |  |  | 2   | 300 | 600  |  |
| 3 |  |  | 3   | 100 | 300  |  |
|   |  |  |     |     |      |  |

①

|  |  |  |  |
|--|--|--|--|
|  |  |  |  |
|  |  |  |  |
|  |  |  |  |
|  |  |  |  |
|  |  |  |  |
|  |  |  |  |
|  |  |  |  |
|  |  |  |  |

②

|  |  |
|--|--|
|  |  |
|--|--|

|  |  |
|--|--|
|  |  |
|  |  |
|  |  |
|  |  |

|   |  |     | ( ) |   |  |
|---|--|-----|-----|---|--|
| 1 |  |     | 4.5 | 2 |  |
| 2 |  |     | 2   | 1 |  |
| 3 |  |     | 3   | 3 |  |
| 4 |  |     | 3   | 1 |  |
|   |  | --- | --- |   |  |

- 
- 
- 
- 

2

|  |   |  |
|--|---|--|
|  |   |  |
|  | 1 |  |



|  |      |      |     |   |    |   |   |    |  |
|--|------|------|-----|---|----|---|---|----|--|
|  | 2    | 2    | 2   | 2 |    | 1 |   | 1  |  |
|  |      |      | 2   |   | 1  |   | 1 | 1  |  |
|  |      | 1    |     | 1 | 1  | F |   | 2  |  |
|  | 2    |      |     | 1 |    | 1 |   |    |  |
|  | 1200 | 1000 | 144 |   | 10 |   |   | 10 |  |
|  |      |      | 2   |   | 1  |   |   |    |  |

3

120

4

|  |  |      |    |      |
|--|--|------|----|------|
|  |  |      |    |      |
|  |  |      |    |      |
|  |  |      |    |      |
|  |  |      |    |      |
|  |  |      | 12 | 0.5  |
|  |  |      | 8  | 2    |
|  |  |      | 3  | 1    |
|  |  | M    |    | 1 10 |
|  |  |      |    | 3    |
|  |  |      |    | 2    |
|  |  | M    | 4  | 1    |
|  |  | (D ) |    | 2    |
|  |  |      | 16 | 2    |

|  |  |  |   |   |  |
|--|--|--|---|---|--|
|  |  |  |   | 2 |  |
|  |  |  |   | 4 |  |
|  |  |  |   | 4 |  |
|  |  |  | 2 |   |  |
|  |  |  |   |   |  |

20.

2-20

1

|  |               |  |                |        |               |
|--|---------------|--|----------------|--------|---------------|
|  | 2009081602    |  |                |        |               |
|  |               |  |                |        |               |
|  |               |  | 6-201          |        | 0731-63415468 |
|  |               |  | 58966326770051 |        |               |
|  | 77            |  |                | 230022 |               |
|  | 0731-69912861 |  | 0731-63415468  |        | 0731-69912880 |
|  | @136.         |  | 58413516       | M N    | @ .           |

|  |    |  |  |                  |  |       |
|--|----|--|--|------------------|--|-------|
|  |    |  |  | 1576784563131450 |  |       |
|  |    |  |  | 100              |  |       |
|  | 15 |  |  |                  |  | 14.75 |
|  |    |  |  | B                |  |       |

|  |               |  |                     |             |               |       |
|--|---------------|--|---------------------|-------------|---------------|-------|
|  | 2003020157    |  |                     |             |               |       |
|  |               |  |                     |             |               |       |
|  |               |  | 18                  |             | 0731-67918998 |       |
|  |               |  | 1202431325876<br>76 |             |               |       |
|  | 56            |  | 23005<br>1          |             |               |       |
|  | 0731-63287689 |  | 0731-66858957       |             | 0731-63287688 |       |
|  | @ .           |  | 698654678           | M N         | @ .           |       |
|  |               |  |                     | 87965687975 |               |       |
|  |               |  |                     | 1200        |               |       |
|  | 100           |  |                     |             |               | 99.99 |
|  |               |  |                     | A           |               |       |

2008160902

3-803

0731-67655865

0-

|   |  |  | ( ) |     |     |  |
|---|--|--|-----|-----|-----|--|
| 1 |  |  | 4.5 | 100 | 450 |  |
| 2 |  |  | 2   | 400 | 800 |  |
| 3 |  |  | 3   | 200 | 600 |  |
| 4 |  |  | 3   | 100 | 300 |  |
|   |  |  |     |     |     |  |

|   |  |  | ( ) |     |      |  |
|---|--|--|-----|-----|------|--|
| 1 |  |  | 5   | 100 | 500  |  |
| 2 |  |  | 2   | 700 | 1400 |  |
| 3 |  |  | 4.5 | 100 | 450  |  |
| 4 |  |  | 3   | 100 | 300  |  |
|   |  |  |     |     |      |  |

①

|  |  |  |  |
|--|--|--|--|
|  |  |  |  |
|  |  |  |  |
|  |  |  |  |
|  |  |  |  |
|  |  |  |  |
|  |  |  |  |
|  |  |  |  |
|  |  |  |  |
|  |  |  |  |

②

|  |  |
|--|--|
|  |  |
|  |  |
|  |  |

|  |  |
|--|--|
|  |  |
|  |  |

|   |  |  | ( ) |   |  |
|---|--|--|-----|---|--|
| 1 |  |  | 2   | 3 |  |
| 2 |  |  | 3   | 8 |  |
| 3 |  |  | 3   | 3 |  |
|   |  |  |     |   |  |

- 
- 
- 
- 

2

|  | 1             |  |
|--|---------------|--|
|  | 2 2 2 2 1 1   |  |
|  | 2 1 1 1 F 2 1 |  |
|  | 2 1 1         |  |

|  |      |      |     |    |    |  |
|--|------|------|-----|----|----|--|
|  | 1200 | 1000 | 144 | 10 | 10 |  |
|  |      |      | 2   | 1  |    |  |

3

120

4

€ 660e

~

|  |  |  |  |   |  |
|--|--|--|--|---|--|
|  |  |  |  | 4 |  |
|  |  |  |  | 4 |  |
|  |  |  |  | 2 |  |
|  |  |  |  |   |  |



### 三、国际物流作业组织与管理模块

1. 3-1

1

1

|  |    |         |
|--|----|---------|
|  |    |         |
|  | 2  | 30      |
|  |    | 1 30 40 |
|  | 0  | 5       |
|  |    | 30      |
|  | 30 | 2       |

3

90

4

5

3  
2

10

(20 )

À Á Ñ

|  |    |  |    |    |
|--|----|--|----|----|
|  | 10 |  | 5  |    |
|  |    |  | 10 |    |
|  | 20 |  | 10 | 20 |
|  |    |  | 10 |    |
|  | 25 |  | 10 |    |
|  |    |  | 10 |    |
|  |    |  | 5  |    |
|  |    |  | 25 |    |

2. 3-2

1

1

,

①

,

:

:

:

:CIF

:

:35

:40

:40

1 - 8

|   |   |   |
|---|---|---|
| 1 |   |   |
|   |   |   |
|   |   |   |
|   |   |   |
| 2 | 4 | 5 |



|  |    |         |
|--|----|---------|
|  |    |         |
|  | 2  | 30      |
|  |    | 1 30 40 |
|  | 0  | 5       |
|  |    | 30      |
|  | 30 | 2       |

3

90

4

|  |    |  |                     |    |
|--|----|--|---------------------|----|
|  |    |  | 2<br>10             | 2  |
|  | 20 |  |                     | 20 |
|  | 25 |  | 10<br>10<br>5<br>25 |    |

3. 3-3

1

1



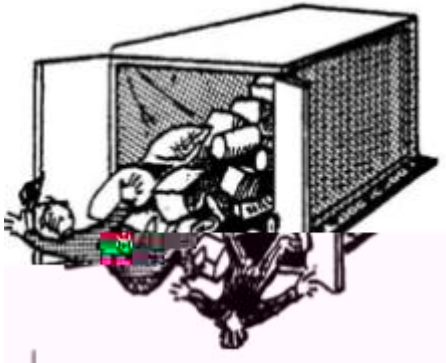
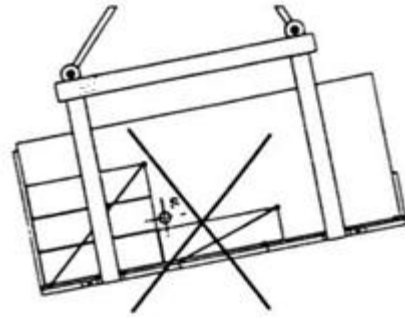

MCO

2020/C NO. 245789

NE 0 K

NO. 1 20

5 20

19.5 3

15

D18.5M

21.5

2

2

|  |    |           |
|--|----|-----------|
|  |    |           |
|  | 2  | 30        |
|  | 0  | 1 30 40 5 |
|  |    | 30        |
|  | 30 | 2         |

3

90

4

|       |    |  |             |   |
|-------|----|--|-------------|---|
|       |    |  |             |   |
| (20 ) | 5  |  | 3<br>2      | 0 |
|       | 10 |  | 4<br>4<br>2 |   |
|       | 5  |  | 2<br>3      |   |
| (80 ) | 15 |  | 3 15        |   |
|       | 10 |  | 5 10        |   |



|  |    |  |     |               |
|--|----|--|-----|---------------|
|  |    |  | I 0 |               |
|  | 10 |  |     | 2 2<br>10     |
|  | 20 |  |     | 20            |
|  | 25 |  |     | 10 10 5<br>25 |

4.

3-4

1

1

A

B

CON AC N .123456

20

①

| 船公司             | 船名/航次                      | 服务代码                     | 航线             | 装船港/卸船港                         | 启-达日期                  | 天   | 挂港   |
|-----------------|----------------------------|--------------------------|----------------|---------------------------------|------------------------|-----|------|
| Carrier         | Ship/Voyage                | Service                  | Lane           | Load/Unload Port                | ETD-ETA                | Day | Port |
| MSC<br>地中海航运    | MASTER<br>74087            |                          | 中国-香港          | HONG KONG 香港<br>HACHUNG 香港      | 02/25 (二)<br>03/15 (二) | 18  | 香港   |
| NYE<br>日本邮船     | ITALIAN EXPRESS<br>E 028   |                          | 中国-香港          | HONG KONG 香港<br>BANGKOK 曼谷      | 02/25 (二)<br>03/02 (二) | 8   | 香港   |
| CMA-CGM<br>中远海运 | CMA CGM GEMINI<br>J004498  |                          | 中国-香港          | XIAMEN 厦门<br>DURBAN 德班          | 02/25 (二)<br>03/07 (二) | 30  | 香港   |
| KLINE<br>德忌利士   | RYUNDAI PLATINUM<br>M 0048 |                          | 中国-香港          | SHANGHAI 上海<br>PAPANAGUA 巴拿马    | 02/25 (二)<br>04/09 (二) | 43  | 香港   |
| EMS<br>招商局      | COSSO KACHILIN<br>S/02846E |                          | 中国-香港          | HONG KONG 香港<br>NOUMEA 努美阿      | 02/25 (二)<br>04/02 (二) | 36  | 香港   |
| PCL<br>长海船务     | ROSA PERMASAN<br>VPM114    |                          | 中国-香港<br>越南-香港 | QINGDAO 青岛<br>MADRAS 马德拉斯       | 02/25 (二)<br>03/18 (二) | 18  | 香港   |
| ZIM<br>中远海运     | KUD HUNG<br>311            | CHINA_VIETN<br>AM OYK    | 中国-香港          | NINGBO 宁波<br>HONG KONG 香港       | 02/25 (二)<br>03/15 (二) | 18  | 香港   |
| SAFARI<br>比利牛斯  | HEBRE P<br>1404            |                          | 中国-香港          | HACHUNG 香港<br>MONTELO           | 02/25 (二)<br>04/05 (二) | 39  | 香港   |
| SEAT<br>长海船务    | SAR SAN NICOLA<br>S 01409  |                          | 中国-香港          | SHANGHAI 上海<br>RIO GRANDE 里奥格兰德 | 02/25 (二)<br>04/07 (二) | 41  | 香港   |
| OOCL<br>东方海外    | OPRESEN EXPRESS<br>S 18808 | Pacific Atl<br>antic FAX | 中国-香港          | SHANGHAI 上海<br>HALIFAX 哈利法克斯    | 02/25 (二)<br>04/14 (二) | 48  | 香港   |

. E D E A

.

.

3

5

A B

20 17.8 A

D BAN CA E O N

D80.0/F D3.0

/M

.

B A ?

D1100.0/ E

10 10 (

)?

.

?

2

2

|  |    |       |
|--|----|-------|
|  |    |       |
|  | 2  | 30    |
|  | 1  | 30 40 |
|  | 0  | 5     |
|  |    | 30    |
|  | 30 | 2     |

3

90

4

|       |    |  |             |   |
|-------|----|--|-------------|---|
|       |    |  |             |   |
| (20 ) | 5  |  | 3<br>2      | 0 |
|       | 10 |  | 4<br>4<br>2 |   |
|       | 5  |  | 2<br>3      |   |
| (80 ) | 15 |  | 5           |   |
|       | 10 |  | 5 10        |   |

|  |    |  |     |                     |
|--|----|--|-----|---------------------|
|  |    |  |     |                     |
|  | 10 |  | I 0 | 10                  |
|  | 20 |  |     | 20                  |
|  | 25 |  |     | 10<br>10<br>5<br>25 |

5.

3-5

1

1

②

③

.

.

4

.

.

.

5

N %

G ,

BEIJING CHINA BJ

BO ON . .A BO

C G  
 G% 32.0K  
 D 1 61 51 42CM

| BEIJING        | CN  |     | BJS    |
|----------------|-----|-----|--------|
| Y.<br>RENMINBI | CNY |     | KGS    |
|                |     |     | 120.00 |
|                |     |     | 75.00  |
|                |     |     | 30.00  |
|                |     | 100 | 12.00  |
|                |     | 100 | 12.00  |

N % GC 200%

2

2

|    |    |         |
|----|----|---------|
|    |    |         |
|    | 2  | 30      |
|    |    | 1 30 40 |
| 0  | 5  |         |
|    | 30 |         |
| 30 | 2  |         |

3

90

4

|       |  |    |     |                     |
|-------|--|----|-----|---------------------|
|       |  |    |     |                     |
| (20 ) |  | 5  |     | 3<br>2              |
|       |  | 10 |     | 4<br>4<br>2         |
|       |  | 5  |     | 2<br>3              |
| (80 ) |  | 15 |     | 10<br>5 15          |
|       |  | 10 |     | 10                  |
|       |  | 10 | I 0 | 5 10                |
|       |  | 20 |     | 7<br>6 20           |
|       |  | 25 |     | 10<br>10<br>5<br>25 |

6.

3-6

1

1

KI

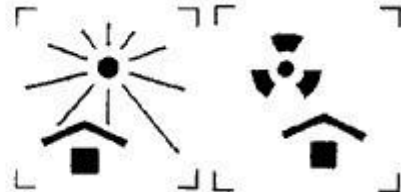

④

5

23

1200

20

20 20 25

100 /

/M

10%

10%

2

2

|  |    |         |
|--|----|---------|
|  |    |         |
|  | 2  | 30      |
|  | 0  | 1 30 40 |
|  | 5  | 30      |
|  | 30 | 2       |

3

90

4

|       |    |  |     |              |
|-------|----|--|-----|--------------|
|       |    |  |     |              |
| (20 ) | 5  |  |     | 3<br>2       |
|       | 10 |  |     | 4<br>4<br>2  |
|       | 5  |  |     | 2<br>3       |
| (80 ) | 15 |  |     | 15           |
|       | 10 |  |     | 4<br>10<br>2 |
|       | 10 |  | I 0 |              |



|  |  |    |  |    |               |
|--|--|----|--|----|---------------|
|  |  |    |  | 10 | 3<br>2        |
|  |  | 20 |  |    | 20            |
|  |  | 25 |  | 25 | 10<br>10<br>5 |

7. 3-7

1

1

②

③

4

5

36.4

82 48

32

6000

1

|                       |          |                            |  |
|-----------------------|----------|----------------------------|--|
| BEIJING<br>. ENMINGBI | CN<br>CN |                            | BJ<br>KG                                   |
| NE O K N C            | . . A    | M<br>N<br>45<br>100<br>300 | 630.00<br>64.46<br>48.34<br>45.19<br>41.80 |

2

2

|    |    |         |  |
|----|----|---------|--|
|    |    |         |  |
|    | 2  | 30      |  |
|    |    | 1 30 40 |  |
| 0  | 5  |         |  |
|    | 30 |         |  |
| 30 | 2  |         |  |

3

90

4

|       |    |  |        |   |
|-------|----|--|--------|---|
|       |    |  |        |   |
| (20 ) | 5  |  | 3<br>2 | 0 |
|       | 10 |  | 4<br>2 |   |
|       | 5  |  |        |   |

|       |  |    |  |               |    |
|-------|--|----|--|---------------|----|
|       |  |    |  | 2<br>3        |    |
| (80 ) |  | 15 |  | 5<br>10       |    |
|       |  | 10 |  |               | 10 |
|       |  | 10 |  | I 0           | 10 |
|       |  | 20 |  |               | 20 |
|       |  | 25 |  | 10<br>10<br>5 | 25 |

8.

3-8

1

1

5

. M.

C20130201

OK 0

N .:1 100

2020 2 15

1 5

|   |   |   |
|---|---|---|
| 1 |   |   |
|   |   |   |
|   |   |   |
| 2 | 4 | 5 |
|   |   |   |
|   |   | / |
| 3 |   |   |
|   |   |   |

---

---

---

---

---

---

---

---

**集装箱设备交接单  
EQUIPMENT INTERCHANGE RECEIPT**

**OUT 出场**

|   |                                 |  |                                |   |                         |
|---|---------------------------------|--|--------------------------------|---|-------------------------|
| 用箱人/运箱人(CNTR. USER/HAULIER)   |                                 |  | 提箱地点(PLACE OF DELIVERY)        |   |                         |
| 发往地点(DELIVERED TO)  |                                 |  | 返回/收箱地点(PLACE OF RETURN)       |   |                         |
| 船名/航次(VESSEL/VOYAGE No.)  |                                 | 集装箱号(CNTR. No.)  |                                | 尺寸/类型(SIZE/TYPER)   |                         |
| 船名/航次(VESSEL/VOYAGE No.)  |                                 | 集装箱号(CNTR. No.)  |                                | 承运人(CNTR. OPTR)   |                         |
| 箱号(CNTR. No.)   | 设备类型(EQUIP. TYPE)               | 箱封号(SEAL No.)  | 免费期限(FREE TIME PERIOD)         | 运载工具牌号(TRUCK WAGON BARGE No.)   |                         |
| 货重(CARGO W.)  | 出场目的/状态(PPS OF GATE-OUT/STATUS) |  | 进场目的/状态(PPS OF GATE-IN/STATUS) |   | 出场日期(TIME-OUT)<br>月 日 时 |
| 出场检查记录(INSPECTION AT THE TIME OF INTERCHANGE)                                 |                                 |  |                                |   |                         |
| 普通集装箱(GP. CNTR.)  |                                 | 冷藏集装箱(REF. CNTR.)  |                                | 特种集装箱(SEL. CNTR.)   |                         |
| <input type="checkbox"/> 正常(SOUND)<br><input type="checkbox"/> 异常(DEFFECTIVE) |                                 | <input type="checkbox"/> 正常(SOUND) 设定温度(SET)<br><input type="checkbox"/> 异常(DEFFECTIVE) 记录温度(RECORDED) |                                | <input type="checkbox"/> 正常(SOUND)<br><input type="checkbox"/> 异常(DEFFECTIVE) |                         |
| 发电机(GEN. SET)   |                                 | 发电机(GEN. SET)  |                                | 发电机(GEN. SET)   |                         |
| <input type="checkbox"/> 正常(SOUND)<br><input type="checkbox"/> 异常(DEFFECTIVE) |                                 | <input type="checkbox"/> 正常(SOUND)<br><input type="checkbox"/> 异常(DEFFECTIVE)                          |                                | <input type="checkbox"/> 正常(SOUND)<br><input type="checkbox"/> 异常(DEFFECTIVE) |                         |
| 损坏记录及代号(DAMAGE CODE)  |                                 |  |                                |   |                         |

. M.  
C20130201  
OK 0  
N .:1 400  
4  
⑤

2

2

|  |    |    |       |
|--|----|----|-------|
|  |    |    |       |
|  | 2  | 30 |       |
|  |    | 1  | 30 40 |
|  | 0  | 5  |       |
|  |    | 30 |       |
|  | 30 | 2  |       |

3

90

4

|       |    |  |             |  |
|-------|----|--|-------------|--|
|       |    |  |             |  |
| (20 ) | 5  |  | 3<br>2      |  |
|       | 10 |  | 4<br>4<br>2 |  |
|       | 5  |  | 2<br>3      |  |
| (80 ) | 15 |  | 3<br>15     |  |
|       | 10 |  |             |  |

5

10

10

10

2

2

10

20

% L (5) % D % (6)  
 F% (7)

| M %<br>N % | N . | D % | G%   | M % |
|------------|-----|-----|------|-----|
|            | (8) | (9) | (10) |     |

(I % )  
 F% C % D

.  
 .  
 .

:  
 B I .A E .C % , M C ., 126  
 % , % ,B B % , 3600 , 20  
 CF , , 10 , 50 \*20 \*30 , 10  
 / , ( ) :ML /AN E EI /NO :1-30 2020 5 18  
 E0002 MA B123456

2

2

|  |   |       |
|--|---|-------|
|  |   |       |
|  | 2 | 30    |
|  | 1 | 30 40 |



|  |    |    |  |
|--|----|----|--|
|  | 0  | 5  |  |
|  |    | 30 |  |
|  | 30 | 2  |  |

3

90

4

|       |    |  |              |  |
|-------|----|--|--------------|--|
|       |    |  |              |  |
| (20 ) | 5  |  | 3<br>2       |  |
|       | 10 |  | 4<br>4<br>2  |  |
|       | 5  |  | 2<br>3       |  |
| (80 ) | 20 |  | 2<br>20      |  |
|       | 20 |  | 20           |  |
|       | 20 |  | 5<br>5<br>20 |  |
|       | 20 |  | 20           |  |

|  |  |  |  |    |  |
|--|--|--|--|----|--|
|  |  |  |  | 20 |  |
|--|--|--|--|----|--|

10. 3-10

1

1)

% % B C %

F% %

.  
.
   
.

CIF

.  
.
   
.

CIF

5

2

2

|   |   |         |  |
|---|---|---------|--|
|   |   |         |  |
|   | 2 | 30      |  |
|   |   | 1 30 40 |  |
| 0 | 5 |         |  |

|    |    |  |
|----|----|--|
|    | 30 |  |
| 30 | 2  |  |

3

90

4

|       |    |  |              |  |
|-------|----|--|--------------|--|
|       |    |  |              |  |
| (20 ) | 5  |  | 3<br>2       |  |
|       | 10 |  | 4<br>4<br>2  |  |
|       | 5  |  | 2<br>3       |  |
| (80 ) | 20 |  | 8<br>6<br>20 |  |
|       | 20 |  | 20           |  |
|       | 20 |  | 20<br>10     |  |
|       | 20 |  | 20<br>10     |  |

11. 3-11

1

1)

% ABC C L  
0% %

N % C L

.  
. .  
. .

C L

CIF

.  
. .  
. .

ABC

100

30

5 :  
2019 ABC

5 6  
10

6

D/

26

2020 3

4

.  
.
2

2

|  |    |         |
|--|----|---------|
|  |    |         |
|  | 2  | 30      |
|  | 0  | 1 30 40 |
|  |    | 5       |
|  |    | 30      |
|  | 30 | 2       |

3

90

4

|       |    |    |        |   |
|-------|----|----|--------|---|
|       |    |    |        |   |
| (20 ) | 5  |    | 3<br>2 |   |
|       | 10 |    | 4<br>4 | 2 |
|       | 5  |    | 2<br>3 |   |
|       |    | 20 |        |   |

|       |  |    |  |    |    |
|-------|--|----|--|----|----|
| (80 ) |  |    |  | 20 |    |
|       |  | 20 |  | 20 |    |
|       |  | 20 |  | 20 | 10 |
|       |  | 20 |  | 10 | 20 |

12. 3-12

1

1)

1

A N 1 C % % N 4 5 A 2-C M  
 N J  
 B % C N M I % E % C % B  
 C  
 % B C B B% F %  
 % % %  
 % % %

. ?  
 . ?  
 . ?  
 2

3

CIF

.

.

.

4

5

2

2

|  |    |         |
|--|----|---------|
|  |    |         |
|  | 2  | 30      |
|  |    | 1 30 40 |
|  | 0  | 5       |
|  |    | 30      |
|  | 30 | 2       |

3

90

4

|       |    |  |        |
|-------|----|--|--------|
|       |    |  |        |
| (20 ) | 5  |  | 3<br>2 |
|       | 10 |  | 4<br>4 |

2

5

2

3

20

(80 )



|                      |          |      |         |
|----------------------|----------|------|---------|
| HANGHAI<br>. ENMINBI | CN<br>CN |      | HA<br>K |
| A I                  | F        | M    | 320.00  |
|                      |          | N    | 50.22   |
|                      |          | 45   | 41.43   |
|                      |          | 300  | 37.90   |
|                      |          | 500  | 33.42   |
|                      |          | 1000 | 30.71   |

| N<br>. | G% | K<br>L | C             | C % | /   |  | N %                |
|--------|----|--------|---------------|-----|-----|--|--------------------|
|        |    |        | C<br>I<br>N . |     | C % |  | G (I .D<br>%)<br>) |
|        |    |        |               |     |     |  |                    |

2

3

4

2

2

|  |  |  |
|--|--|--|
|  |  |  |
|--|--|--|

|  |    |    |       |
|--|----|----|-------|
|  | 2  | 30 |       |
|  | 0  | 1  | 30 40 |
|  | 5  | 30 |       |
|  | 30 | 2  |       |

3

90

4

|       |    |  |             |  |
|-------|----|--|-------------|--|
|       |    |  |             |  |
| (20 ) | 5  |  | 3<br>2      |  |
|       | 10 |  | 4<br>4<br>2 |  |
|       | 5  |  | 2<br>3      |  |
| (80 ) | 20 |  | 20          |  |
|       | 20 |  | 20          |  |
|       | 20 |  | 20<br>10    |  |
|       | 20 |  |             |  |

|  |  |  |  |    |    |  |
|--|--|--|--|----|----|--|
|  |  |  |  | 10 | 20 |  |
|--|--|--|--|----|----|--|

14. 3-14

1

1

:

.

.

.

.

.

.

.

. CO. L D.

. CO. L D. ?

.

%

B/L N .

HANGHAI KNI EA  
IM O & E O  
CO O A ION

HANGHAI

COMBINED AN O  
BILL OF LADING

C % % %

O O DE

ECEI E %

N %

% % % . HE

CO. L D. ,

EL NO 81-525-73256

C %% %, %

FA : 81-525-73286

%

% - %%

O % L

1) % , % % % % %  
% % %



•  
•

•  
•  
•

CIF 12000

0.6% 0.4%

5  
2019 9 8

12000 /  
10 16

3 11 5 12 14

12000

2

2

|  |   |    |
|--|---|----|
|  |   |    |
|  | 2 | 30 |

|  |    |       |
|--|----|-------|
|  |    |       |
|  | 1  | 30 40 |
|  | 0  | 5     |
|  |    | 30    |
|  | 30 | 2     |

3

90

4

5

(20 )

|  |  |  |  |    |  |
|--|--|--|--|----|--|
|  |  |  |  | 20 |  |
|--|--|--|--|----|--|

15. 3-15

1

1

B CHINA BJ AM E DAM HOLLAND AM  
 C % A  
 G% 38.6  
 D 101 58 32

|           |    |           |
|-----------|----|-----------|
| BEIJING   | CN | BJ        |
| . ENMINBI | CN | K         |
| AM E DAM  | NL | M 320.00  |
|           |    | N 50.22   |
|           |    | 45 41.53  |
|           |    | 300 37.52 |

|     |    |        |   |     |          |                          |
|-----|----|--------|---|-----|----------|--------------------------|
| N . | G% | K<br>L | C | C % | /<br>C % | N %<br>G (I<br>.D<br>% ) |
| -   |    |        |   |     |          |                          |

|  |  |  |  |     |  |  |  |  |
|--|--|--|--|-----|--|--|--|--|
|  |  |  |  | C   |  |  |  |  |
|  |  |  |  | I   |  |  |  |  |
|  |  |  |  | N . |  |  |  |  |
|  |  |  |  |     |  |  |  |  |

④

:

2

38.6

D320000

999-8334-



4

|       |    |    |             |   |
|-------|----|----|-------------|---|
|       |    |    |             |   |
| (20 ) | 5  |    | 3<br>2      | 0 |
|       | 10 |    | 4<br>4<br>2 |   |
|       | 5  |    | 2<br>3      |   |
| (80 ) |    | 20 | 20          |   |
|       |    | 20 | 20          |   |
|       |    | 20 | 20<br>10    |   |
|       |    | 20 | 20          |   |

16.

3-16

1

1)

2019 8

ABC

:

% ABC C . L . C O O DE  
N % C . L . O M  
% L : % D % :

M % :1234CN/5678J

D % G : EHICLE 2\*20 C 4 NI  
CO 8001215 OC 802376  
F% %

N . O% B/L:  
% % :DEF C .,L .A ACEN FO CHI C .,L .A

CA IE

CO OC

.

.

.

.

.

.

.

. C .,L .

.

C .,L .

.

.

·  
·

2019 8 ABC FOB

2

2

|  |    |         |  |
|--|----|---------|--|
|  |    |         |  |
|  | 2  | 30      |  |
|  |    | 1 30 40 |  |
|  | 0  | 5       |  |
|  |    | 30      |  |
|  | 30 | 2       |  |

3

90

4

|       |    |  |   |  |
|-------|----|--|---|--|
|       |    |  |   |  |
| (20 ) | 5  |  | 3 |  |
|       | 10 |  | 2 |  |
|       |    |  | 4 |  |

|       |  |    |  |    |    |
|-------|--|----|--|----|----|
|       |  |    |  | 4  | 2  |
|       |  | 5  |  | 2  | 3  |
| (80 ) |  | 20 |  |    | 20 |
|       |  | 20 |  | 20 |    |
|       |  | 20 |  | 20 | 10 |
|       |  | 20 |  | 10 | 20 |

17. 3-17

1

2 20 J

MM A

2 21 18: 00

100

2 21 18: 30

A

10

1)

②

③

?

\*

|   |  |  |     |
|---|--|--|-----|
| * |  |  |     |
| * |  |  | 001 |
| * |  |  |     |
| * |  |  |     |
| * |  |  |     |
| * |  |  |     |
|   |  |  |     |

: : :

18: 00

2020. 02. 21 02: 00

2 20



4

|       |    |  |             |  |
|-------|----|--|-------------|--|
|       |    |  |             |  |
| (20 ) | 5  |  | 3<br>2      |  |
|       | 10 |  | 4<br>4<br>2 |  |
|       | 5  |  | 2<br>3      |  |
| (80 ) | 15 |  | 5<br>15     |  |
|       | 15 |  | 15          |  |
|       | 30 |  | 30<br>15    |  |
|       | 20 |  | 20<br>10    |  |

18.

3-18

1

A B

FOB

D

D

A

B

A

A

B

1

B

@126.

2

2

|    |    |       |
|----|----|-------|
|    |    |       |
|    | 2  | 30    |
|    | 1  | 30 40 |
| 0  | 4  |       |
|    | 30 |       |
| 30 | 2  |       |

|          |  |    |  |    |    |
|----------|--|----|--|----|----|
|          |  |    |  | 4  | 2  |
|          |  | 5  |  | 2  | 3  |
| (80<br>) |  | 15 |  | 5  | 15 |
|          |  | 15 |  | 15 | 5  |
|          |  | 30 |  | 30 | 15 |
|          |  | 20 |  | 20 | 10 |

19.

3-19

1

20 80



2

2

|   |    |         |
|---|----|---------|
|   |    |         |
|   | 2  | 30      |
|   |    | 1 30 40 |
| 0 | 4  |         |
|   | 30 |         |
|   | 30 | 2       |

3

90

4

|       |   |  |   |  |
|-------|---|--|---|--|
|       |   |  |   |  |
| (20 ) | 5 |  | 3 |  |

|          |    |    |  |      |
|----------|----|----|--|------|
|          |    |    |  | 2    |
|          |    |    |  | 4    |
|          | 10 |    |  | 4    |
|          |    |    |  | 2    |
|          | 5  |    |  | 2    |
|          |    |    |  | 3    |
| (80<br>) |    | 15 |  | 7 8  |
|          |    |    |  | 15   |
|          |    | 15 |  | 7    |
|          |    |    |  | 8 15 |
|          |    | 30 |  | 15   |
|          |    |    |  | 30   |
|          |    | 20 |  | 10   |
|          |    |    |  | 20   |

20.

3-20

1

1907

34

2400

16

610

:

1.

3

;

8

1

20

90

180

24

2.

3.

4.

5.

①

3

2

2

|  |    |         |
|--|----|---------|
|  |    |         |
|  | 2  | 30      |
|  |    | 1 30 40 |
|  | 0  | 4       |
|  |    | 30      |
|  | 30 | 2       |

|  |  |  |
|--|--|--|
|  |  |  |
|--|--|--|

3

90

4

|       |    |  |             |  |
|-------|----|--|-------------|--|
|       |    |  |             |  |
| (20 ) | 5  |  | 3<br>2      |  |
|       | 10 |  | 4<br>4<br>2 |  |
|       | 5  |  | 2<br>3      |  |
| (80 ) | 15 |  | 5<br>15     |  |
|       | 15 |  | 15<br>5     |  |
|       | 30 |  | 30<br>15    |  |
|       | 20 |  | 20<br>10    |  |

21.

3-21

1

1990

2004

. % .

4000204446

2004

200

2007

6000

1990

3

200

300

4000204446

. % .

24

1)

18

2

3

2

2

|  |    |    |       |
|--|----|----|-------|
|  |    |    |       |
|  | 2  | 30 |       |
|  |    | 1  | 30 40 |
|  | 0  | 4  |       |
|  |    | 30 |       |
|  | 30 | 2  |       |

3

90

4

|       |    |  |             |  |
|-------|----|--|-------------|--|
|       |    |  |             |  |
| (20 ) | 5  |  | 3<br>2      |  |
|       | 10 |  | 4<br>4<br>2 |  |
|       | 5  |  | 2<br>3      |  |
| (80 ) | 15 |  | 5<br>15     |  |
|       | 15 |  |             |  |

|  |    |  |           |  |
|--|----|--|-----------|--|
|  |    |  | 7<br>8 15 |  |
|  | 30 |  | 15<br>30  |  |
|  | 20 |  | 10<br>20  |  |

22.

3-22

1

( ) ( ) 1961 4

27 700 4100

4 160 1400

32 147

4000 77 104

29 400

C

2002

C

%

1)

18

2

3

2

2

|  |   |    |
|--|---|----|
|  |   |    |
|  | 2 | 30 |



|    |    |    |    |
|----|----|----|----|
|    | 1  | 30 | 40 |
| 0  | 4  |    |    |
|    | 30 |    |    |
| 30 | 2  |    |    |

3

90

4

|       |    |  |              |  |
|-------|----|--|--------------|--|
|       |    |  |              |  |
| (20 ) | 5  |  | 3<br>2       |  |
|       | 10 |  | 4<br>4<br>2  |  |
|       | 5  |  | 2<br>3       |  |
| (80 ) | 15 |  | 15           |  |
|       | 15 |  | 8<br>7<br>15 |  |
|       | 30 |  | 30<br>15     |  |
|       | 20 |  | 10           |  |

|  |  |  |  |    |  |
|--|--|--|--|----|--|
|  |  |  |  | 20 |  |
|--|--|--|--|----|--|

23. 3-23

1

2020 4 20

A B

A B 2020 6 9

B

C

1)

①

②

③

2

2

|    |    |         |
|----|----|---------|
|    |    |         |
|    | 2  | 30      |
|    |    | 1 30 40 |
| 0  | 4  |         |
|    | 30 |         |
| 30 | 2  |         |

3

90

4

5

3

2

4

(20 )

10

4

2

5

2

3

15

7

8

15

15

15

(80 )

30

10

30

20

WZ (TM 7



|          |  |    |  |    |    |
|----------|--|----|--|----|----|
|          |  |    |  | 4  | 2  |
|          |  | 5  |  | 2  | 3  |
| (80<br>) |  | 15 |  | 5  | 15 |
|          |  | 15 |  |    | 15 |
|          |  | 30 |  | 30 | 15 |
|          |  | 20 |  | 20 | 10 |

25.

3-25

1

3

FOB

3

2

2

1)

2

?

2

2

|  |    |         |
|--|----|---------|
|  |    |         |
|  | 2  | 30      |
|  |    | 1 30 40 |
|  | 0  | 4       |
|  |    | 30      |
|  | 30 | 2       |

3

90

4

|       |    |  |             |  |
|-------|----|--|-------------|--|
|       |    |  |             |  |
| (20 ) | 5  |  | 3<br>2      |  |
|       | 10 |  | 4<br>4<br>2 |  |
|       | 5  |  | 2<br>3      |  |

|          |    |  |         |    |
|----------|----|--|---------|----|
| (80<br>) | 15 |  | 7<br>15 | 8  |
|          | 15 |  |         | 15 |
|          | 30 |  | 30      | 10 |
|          | 20 |  | 20      | 10 |

## 四、 快递物流作业组织与管理模块

1. 4-1

1

1

:

20100289B

3

2013 11 29

2013 12 20

2 11 29

3

2013 11 30



1

2

M 4

3

4

4

?

4

5

60

40

30

5

6

12

|  |    |   |
|--|----|---|
|  |    |   |
|  | 1  |   |
|  | 10 | 8 |

7

8

,

?

2

2

|   |         |  |
|---|---------|--|
|   |         |  |
|   | 1 30    |  |
|   | 1 30 40 |  |
| 0 | 5       |  |

|    |    |  |
|----|----|--|
|    | 30 |  |
| 30 | 2  |  |

3

90

4

|  |    |  |  |           |
|--|----|--|--|-----------|
|  |    |  |  |           |
|  |    |  |  |           |
|  | 10 |  |  | 5<br>5    |
|  | 10 |  |  | 0         |
|  | 10 |  |  | 2<br>8    |
|  | 10 |  |  | 1<br>6    |
|  | 10 |  |  | 8 2       |
|  | 10 |  |  | 8 2       |
|  | 10 |  |  | 5<br>10 2 |
|  | 20 |  |  | 10<br>2   |
|  | 10 |  |  | 5<br>1    |

2.

4-2

1

1

6000

51

9 18

13

117

10

3

3

3

3

12 24

6000

:// . % . /

3

2

8860

44300

A2141552

"

1

2

M 4

3

4

4

?

4

5

60

40

30

5

6

12

|  |    |   |
|--|----|---|
|  |    |   |
|  | 1  |   |
|  | 10 | 8 |

7

8

,

?

2

2

|   |   |    |       |
|---|---|----|-------|
|   |   |    |       |
|   | 1 | 30 |       |
|   |   | 1  | 30 40 |
| 0 | 5 |    |       |

|    |    |  |
|----|----|--|
|    | 30 |  |
| 30 | 2  |  |

3

90

4

|  |    |    |    |   |
|--|----|----|----|---|
|  |    |    |    |   |
|  |    |    |    |   |
|  | 10 |    | 5  |   |
|  |    |    | 5  |   |
|  | 10 |    | 5  | 0 |
|  |    |    | 5  |   |
|  | 10 |    | 2  |   |
|  |    |    | 8  |   |
|  |    |    | 1  |   |
|  | 10 |    | 6  |   |
|  |    |    | 1  |   |
|  | 10 |    | 8  | 2 |
|  |    |    | 8  | 2 |
|  | 10 |    | 5  |   |
|  |    | 10 |    | 2 |
|  | 20 |    | 10 |   |
|  |    |    |    | 2 |
|  | 10 |    | 5  |   |
|  |    | 1  |    |   |

3.

4-3

1

1

50

50

3

5000

2

2

8

4

:// . . / / / /321751.

1

2

M 4

3

4

4

?

4

5

60

40

30

5

6

12

|  |    |   |
|--|----|---|
|  |    |   |
|  | 1  |   |
|  | 10 | 8 |

7

8

,

?

2

2

|  |   |    |
|--|---|----|
|  |   |    |
|  | 1 | 30 |



|  |    |       |
|--|----|-------|
|  |    |       |
|  | 1  | 30 40 |
|  | 0  | 5     |
|  |    | 30    |
|  | 30 | 2     |

3

90

4

|  |    |  |    |    |
|--|----|--|----|----|
|  |    |  |    |    |
|  |    |  |    |    |
|  | 10 |  |    | 5  |
|  |    |  |    | 5  |
|  | 10 |  |    | 0  |
|  |    |  |    | 5  |
|  | 10 |  |    | 2  |
|  |    |  |    | 8  |
|  |    |  |    | 1  |
|  | 10 |  |    | 6  |
|  |    |  |    | 1  |
|  | 10 |  |    | 8  |
|  |    |  |    | 2  |
|  | 10 |  |    | 8  |
|  |    |  |    | 2  |
|  | 10 |  |    | 5  |
|  |    |  | 10 | 2  |
|  | 20 |  |    | 10 |
|  |    |  |    | 2  |

|  |  |    |  |                |  |
|--|--|----|--|----------------|--|
|  |  | 10 |  | 1 <sup>5</sup> |  |
|--|--|----|--|----------------|--|

4.

4-4

1

1

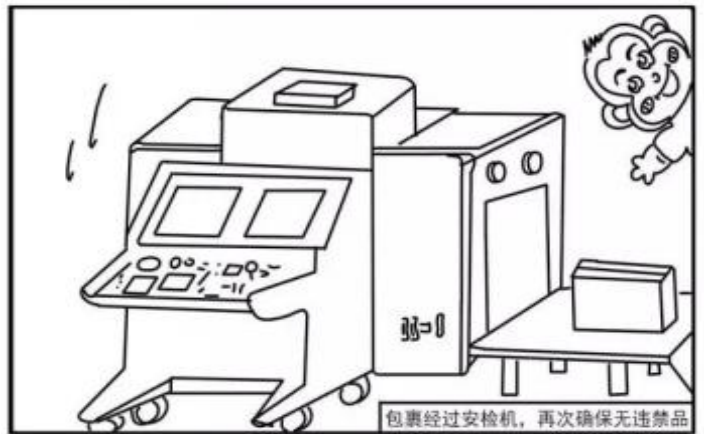
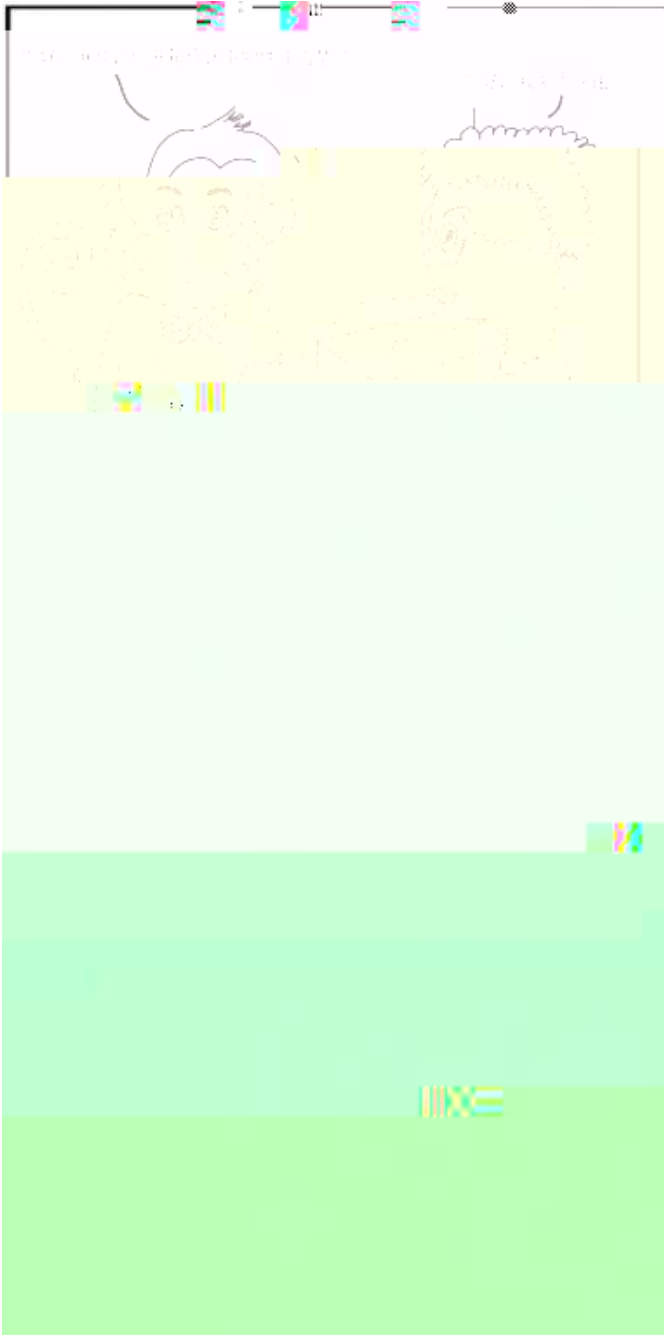

1

2

M 4

3

4

4

?

4

5

60

40

30

5

6

12

|  |    |   |
|--|----|---|
|  |    |   |
|  | 1  |   |
|  | 10 | 8 |

7

8

,

?

2

2

1

-

"

|  |    |       |
|--|----|-------|
|  |    |       |
|  | 1  | 30 40 |
|  | 0  | 5     |
|  |    | 30    |
|  | 30 | 2     |

3

90

4

|  |    |  |  |             |
|--|----|--|--|-------------|
|  |    |  |  |             |
|  |    |  |  |             |
|  | 10 |  |  | 5<br>5      |
|  | 10 |  |  | 5<br>5<br>0 |
|  | 10 |  |  | 2<br>8      |
|  | 10 |  |  | 1<br>6      |
|  | 10 |  |  | 1<br>8 2    |
|  | 10 |  |  | 8 2         |
|  | 10 |  |  | 5<br>10 2   |
|  | 20 |  |  | 10<br>2     |

|  |  |    |  |                |  |
|--|--|----|--|----------------|--|
|  |  | 10 |  | 1 <sup>5</sup> |  |
|--|--|----|--|----------------|--|

5. 4-5

1

1

1

2018 4

2

2

M 4

3

4

4

?

4

5

60

40

30

5

6

12

|  |    |   |
|--|----|---|
|  |    |   |
|  | 1  |   |
|  | 10 | 8 |

7

8

,

?

2

2

|    |    |         |
|----|----|---------|
|    |    |         |
|    | 1  | 30      |
|    |    | 1 30 40 |
| 0  | 5  |         |
|    | 30 |         |
| 30 | 2  |         |



|  |  |  |
|--|--|--|
|  |  |  |
|--|--|--|

3

90

4

|  |    |  |  |             |
|--|----|--|--|-------------|
|  |    |  |  |             |
|  |    |  |  |             |
|  | 10 |  |  | 5<br>5      |
|  | 10 |  |  | 5<br>5<br>0 |
|  | 10 |  |  | 2<br>8<br>1 |
|  | 10 |  |  | 6<br>1      |
|  | 10 |  |  | 8 2         |
|  | 10 |  |  | 8 2         |
|  | 10 |  |  | 5<br>10 2   |
|  | 20 |  |  | 10<br>2     |
|  | 10 |  |  | 5<br>1      |

6.

4-6

1

1

, , ( ) ,

90

, ,

, ,

,

,

,

10

,

1

,

4000

( )

,

,

,

,

10

,

5000

1

2

M 4

3

4

4

?

4

5

60

40

30

5

6

12

|  |    |   |
|--|----|---|
|  |    |   |
|  | 1  |   |
|  | 10 | 8 |

7

8

,

?

2

2

|    |         |  |
|----|---------|--|
|    |         |  |
|    | 1 30    |  |
|    | 1 30 40 |  |
| 0  | 5       |  |
|    | 30      |  |
| 30 | 2       |  |

3

90

4

|  |  | 10 |  | 5<br>5      |   |
|--|--|----|--|-------------|---|
|  |  | 10 |  | 5<br>5      | 0 |
|  |  | 10 |  | 2<br>8<br>1 |   |
|  |  | 10 |  | 6<br>1      |   |
|  |  | 10 |  | 8 2         |   |
|  |  | 10 |  | 8 2         |   |
|  |  | 10 |  | 5<br>10 2   |   |
|  |  | 20 |  | 10<br>2     |   |
|  |  | 10 |  | 5<br>1      |   |

7. 4-7

1

1

7

5000

2000

50 250

250

9

14

7000

18K

1

5 8

5

10

( )

10

30

<://.360./ /998684 3 4 3 ? =4>

& % = % & =360 57 3 1&% % = 1

1

2

M 4

3

4

4

?

4

5

60

40

30

5

6

12

|  |    |   |
|--|----|---|
|  |    |   |
|  | 1  |   |
|  | 10 | 8 |

7

8

,

?

2

2

|  |   |    |
|--|---|----|
|  |   |    |
|  | 1 | 30 |

|  |    |    |    |
|--|----|----|----|
|  | 1  | 30 | 40 |
|  | 0  | 5  |    |
|  |    | 30 |    |
|  | 30 | 2  |    |

3

90

4

|  |    |  |    |   |
|--|----|--|----|---|
|  |    |  |    |   |
|  |    |  |    |   |
|  | 10 |  | 5  |   |
|  |    |  | 5  |   |
|  | 10 |  | 5  | 0 |
|  |    |  | 5  |   |
|  | 10 |  | 2  |   |
|  |    |  | 8  |   |
|  |    |  | 1  |   |
|  | 10 |  | 6  |   |
|  |    |  | 1  |   |
|  | 10 |  | 8  | 2 |
|  |    |  | 8  | 2 |
|  | 10 |  | 5  |   |
|  |    |  | 10 | 2 |
|  | 20 |  | 10 | 2 |
|  |    |  | 5  |   |
|  | 10 |  | 1  |   |

|  |  |  |  |  |  |
|--|--|--|--|--|--|
|  |  |  |  |  |  |
|--|--|--|--|--|--|



8. 4-8

1

1

[想知道: 中国成都理工大学校园快递具体在哪? 百度知道](#)

3个回答 - 提问时间: 2014年02月10日

最佳答案: 韵达在银杏后面。宝盒、圆通、顺丰在电影院后面。中通、申通在图书馆下面。常用的是这几个。

[zhidao.baidu.com/link?... 2014-02-15](#) - 百度快照 - 80%好评

10

60

300

2

0.5

150

4500

60

120

3600

8100

8100

8100

2

250

24

A M

0.2

0.1

0.1

20%

70%

1

2



4

|  |    |  |  |             |
|--|----|--|--|-------------|
|  |    |  |  |             |
|  |    |  |  |             |
|  | 10 |  |  | 5<br>5      |
|  | 10 |  |  | 5<br>5<br>0 |
|  | 10 |  |  | 2<br>8<br>1 |
|  | 10 |  |  | 6<br>1      |
|  | 10 |  |  | 8 2         |
|  | 10 |  |  | 8 2         |
|  | 10 |  |  | 5<br>10 2   |
|  | 20 |  |  | 10<br>2     |
|  | 10 |  |  | 5<br>1      |



200

\*

200

\*

1

2

M 4

3

4

4

?

4

5

60

40

30

5

6

12

|  |    |   |
|--|----|---|
|  |    |   |
|  | 1  |   |
|  | 10 | 8 |

7

8

,

?

2

2

|    |    |       |
|----|----|-------|
|    |    |       |
|    | 1  | 30    |
|    | 1  | 30 40 |
| 0  | 5  |       |
|    | 30 |       |
| 30 | 2  |       |

3

90

4

|  |    |  |             |
|--|----|--|-------------|
|  |    |  |             |
|  |    |  |             |
|  | 10 |  | 5<br>5      |
|  | 10 |  | 5<br>5<br>0 |
|  | 10 |  | 2<br>8<br>1 |
|  | 10 |  | 6<br>1      |
|  | 10 |  | 8 2         |
|  | 10 |  | 8 2         |

|  |  |    |  |                   |  |
|--|--|----|--|-------------------|--|
|  |  | 10 |  | 10 <sup>5</sup> 2 |  |
|  |  | 20 |  | 10 <sup>2</sup>   |  |
|  |  | 10 |  | 1 <sup>5</sup>    |  |



10.

4-10

1

1

65 (

)

20100289B

3

1

----

2

M 4

3

4

4

?

4

5

60

40

30

5

6

12

|  |    |   |
|--|----|---|
|  |    |   |
|  | 1  |   |
|  | 10 | 8 |

7

8

,

?

2

2

|  |    |         |  |
|--|----|---------|--|
|  |    |         |  |
|  | 1  | 30      |  |
|  |    | 1 30 40 |  |
|  | 0  | 5       |  |
|  | 30 |         |  |
|  | 30 | 2       |  |

3

90

4

|  |  |  |  |
|--|--|--|--|
|  |  |  |  |
|--|--|--|--|

|    |    |    |   |   |
|----|----|----|---|---|
|    |    |    |   |   |
|    | 10 |    | 5 | 0 |
|    |    |    | 5 |   |
|    | 10 |    | 5 |   |
|    |    |    | 2 |   |
|    | 10 |    | 8 |   |
|    |    |    | 1 |   |
|    | 10 |    | 6 |   |
|    |    |    | 1 |   |
|    | 10 |    | 8 | 2 |
|    |    | 8  | 2 |   |
| 10 |    | 5  |   |   |
|    |    | 10 | 2 |   |
| 20 |    | 10 | 2 |   |
|    |    | 5  |   |   |
| 10 |    | 1  |   |   |

11.

4-11

1

1

9

1

2

3

4

5

6

7

8

2

2

|  |    |         |
|--|----|---------|
|  |    |         |
|  | 1  | 30      |
|  |    | 1 30 40 |
|  | 0  | 5       |
|  |    | 30      |
|  | 30 | 2       |

3

90

4

|  |    |  |   |   |
|--|----|--|---|---|
|  |    |  |   |   |
|  |    |  |   |   |
|  | 10 |  | 5 |   |
|  |    |  | 5 |   |
|  | 10 |  | 5 | 0 |
|  |    |  | 5 |   |
|  | 15 |  | 5 |   |
|  |    |  | 1 |   |

|  |  |    |  |          |  |
|--|--|----|--|----------|--|
|  |  | 10 |  | 5 5<br>1 |  |
|  |  | 10 |  | 5<br>1   |  |
|  |  | 15 |  | 5<br>1   |  |
|  |  | 10 |  | 5<br>2   |  |
|  |  | 10 |  | 5<br>5   |  |
|  |  | 10 |  | 5        |  |

12.

4-12

1

1

8 4 17

11

8 5 17

8 6

8 6 16

16

4008111111

1

2

3

4

5

6

10

7

8

2

2

|    |         |  |
|----|---------|--|
|    |         |  |
|    | 1 30    |  |
|    | 1 30 40 |  |
| 0  | 5       |  |
|    | 30      |  |
| 30 | 2       |  |

3

90

4

10



|  |  |    |          |  |
|--|--|----|----------|--|
|  |  |    | 5        |  |
|  |  | 15 | 5<br>1   |  |
|  |  | 10 | 5 5<br>1 |  |
|  |  | 10 | 5<br>1   |  |
|  |  | 15 | 5<br>1   |  |
|  |  | 10 | 5<br>2   |  |
|  |  | 10 | 5<br>5   |  |
|  |  | 10 | 5        |  |

13.

4-13

1

1

12

298

12 19

298

10

1880

220

10

220

1

2

3

4

5

6

7

8

2

2

|    |         |  |
|----|---------|--|
|    |         |  |
|    | 1 30    |  |
|    | 1 30 40 |  |
| 0  | 5       |  |
|    | 30      |  |
| 30 | 2       |  |

3

90

4

|  |  |  |  |
|--|--|--|--|
|  |  |  |  |
|--|--|--|--|

|  |    |  |  |             |
|--|----|--|--|-------------|
|  |    |  |  |             |
|  | 10 |  |  | 5<br>5      |
|  | 10 |  |  | 5<br>5<br>0 |
|  | 15 |  |  | 5<br>1      |
|  | 10 |  |  | 5 5<br>1    |
|  | 10 |  |  | 5<br>1      |
|  | 15 |  |  | 5<br>1      |
|  | 10 |  |  | 5<br>2      |
|  | 10 |  |  | 5<br>5      |
|  | 10 |  |  | 5           |
|  | 10 |  |  | 5           |

14. 4-14

1

1

5 1

470 8000

8

10

6200

10 23

12 1

3

M

1

2

3

4

5

6

7

8

|  |  |    |  |     |   |
|--|--|----|--|-----|---|
|  |  | 10 |  | 5   | 0 |
|  |  | 15 |  | 5   |   |
|  |  | 10 |  | 5 5 |   |
|  |  | 10 |  | 1   |   |
|  |  | 10 |  | 5   | 1 |
|  |  | 15 |  | 5   | 1 |
|  |  | 10 |  | 5   |   |
|  |  | 10 |  | 5   | 2 |
|  |  | 10 |  | 5   | 5 |
|  |  | 10 |  | 5   |   |

15.

4-15

1

1

1

8 4 17

11

8 5 17

8 6

8 6 16

16

4008111111

( )

1

2

3



4

5

6

7

8

2

2

|    |         |  |
|----|---------|--|
|    |         |  |
|    | 1 30    |  |
|    | 1 30 40 |  |
| 0  | 5       |  |
|    | 30      |  |
| 30 | 2       |  |

3

90

4

|  |  |    |  |          |
|--|--|----|--|----------|
|  |  |    |  |          |
|  |  | 15 |  | 5<br>1   |
|  |  | 10 |  | 5 5<br>1 |
|  |  | 10 |  | 5<br>1   |
|  |  | 15 |  | 5<br>1   |
|  |  | 10 |  | 5<br>2   |
|  |  | 10 |  | 5<br>5   |
|  |  | 10 |  | 5        |
|  |  |    |  |          |

16.

4-16

1

1

11 23

11 24

45KG

0.3

11 25

11 26

12 3

12 6

1

2 11 26

3

4

?

5

6

7

?

8

2

2

|  |              |  |
|--|--------------|--|
|  |              |  |
|  | 1 30         |  |
|  | 1 30 40<br>0 |  |
|  | 5            |  |
|  | 30           |  |
|  | 30 2         |  |

3

90

4

|  |    |  |   |
|--|----|--|---|
|  |    |  |   |
|  |    |  |   |
|  | 10 |  | 5 |
|  |    |  | 5 |

|  |  |    |  |    |    |    |
|--|--|----|--|----|----|----|
|  |  | 10 |  | 5  | 5  | 0  |
|  |  | 15 |  | 1  |    |    |
|  |  | 15 |  | 5  | 10 |    |
|  |  | 10 |  | 5  | 5  |    |
|  |  | 10 |  | 5  | 1  |    |
|  |  | 15 |  | 5  | 5  |    |
|  |  | 15 |  | 5  | 2  | 10 |
|  |  | 15 |  | 5  | 1  |    |
|  |  | 15 |  | 10 |    |    |
|  |  |    |  | 1  |    |    |

17. 4-17

1

1

A

11 19

A

11 20

11 20

A

11 27

11 27

A

A11

28

11 28

A

17 30

A A

11

29

A

9 15

A

A

11 29

9 30 A

28

11 29

10

15

3

4

A

11 29

14 00 A

A

11 29 14 15 A

A

A

A

A

1

2

A

3

A

4

4

?

5

6

7

?

8

2

2

|  |    |            |
|--|----|------------|
|  |    |            |
|  | 1  | 30         |
|  | 1  | 30 40<br>0 |
|  | 5  |            |
|  | 30 |            |
|  | 30 | 2          |

3

90

4

|  |    |  |    |   |
|--|----|--|----|---|
|  |    |  |    |   |
|  |    |  |    |   |
|  | 10 |  | 5  |   |
|  |    |  | 5  |   |
|  | 10 |  | 5  | 0 |
|  |    |  | 5  |   |
|  | 15 |  |    | 1 |
|  |    |  | 5  |   |
|  | 15 |  | 10 |   |
|  |    |  | 5  |   |



10 5 5 5  
10 1 5 5 5  
15 5 1 10  
15 5 2 10  
15

18.

4-18

1

1

8

800

10

8

2

10 /

10

9 /

8 12

7

2080

1

2

3

4

5

6

7

?

8

2

2

1

30

1

30 40

|  |  |    |  |        |    |
|--|--|----|--|--------|----|
|  |  | 10 |  | 5      |    |
|  |  | 10 |  | 5<br>5 |    |
|  |  | 10 |  | 1      | 5  |
|  |  | 15 |  | 5      | 1  |
|  |  | 15 |  | 5      | 2  |
|  |  | 15 |  | 1      | 10 |
|  |  | 15 |  | 1      | 5  |
|  |  | 15 |  | 1      | 10 |

19.

4-19

1

1

8 20

10

123

12

0291234567

11

0281234567

234

10

10

1

2

3

4

?

5

6

7

?

8

2

2

|  |    |            |
|--|----|------------|
|  |    |            |
|  | 1  | 30         |
|  | 1  | 30 40<br>0 |
|  | 5  |            |
|  | 30 |            |
|  | 30 | 2          |

3

90

4

|  |    |  |   |   |
|--|----|--|---|---|
|  |    |  |   |   |
|  |    |  |   |   |
|  | 10 |  | 5 |   |
|  |    |  | 5 |   |
|  | 10 |  | 5 | 5 |
|  |    |  | 5 | 0 |
|  | 15 |  |   | 1 |

|  |  |    |  |              |         |
|--|--|----|--|--------------|---------|
|  |  | 15 |  | 5<br>10<br>5 |         |
|  |  | 10 |  | 5<br>5<br>1  | 5       |
|  |  | 10 |  | 5<br>1       | 5       |
|  |  | 15 |  | 2<br>5       | 10      |
|  |  | 15 |  | 1<br>1       | 5<br>10 |

20.

4-20

1

1

5 23

5 24

3876

45KG

0.3

5 25

5 26

6 3

6 6

\*\*

1

2 11 26

3

4

?



5

6

7

?

8

2

2

|  |    |            |
|--|----|------------|
|  |    |            |
|  | 1  | 30         |
|  | 1  | 30 40<br>0 |
|  | 5  |            |
|  | 30 |            |
|  | 30 | 2          |

3

90

4

|  |    |   |   |
|--|----|---|---|
|  |    |   |   |
|  |    |   |   |
|  | 10 |   | 5 |
|  | 10 |   | 5 |
|  |    | 5 | 0 |

|  |    |  |              |         |
|--|----|--|--------------|---------|
|  |    |  | 5            |         |
|  | 15 |  | 1            |         |
|  | 15 |  | 5<br>10<br>5 |         |
|  | 10 |  | 5<br>5<br>1  | 5       |
|  | 10 |  | 5<br>1       | 5       |
|  | 15 |  | 2<br>5       | 10      |
|  | 15 |  | 1<br>1       | 5<br>10 |

21. 4-21

1

1

11 23

11 24

45KG

0.3

11 25

11 26

12 3

12 6

1

2 11 26

3

4

?

5

6

7

?

8

2

2

|  |              |  |
|--|--------------|--|
|  |              |  |
|  | 1 30         |  |
|  | 1 30 40<br>0 |  |
|  | 5            |  |
|  | 30           |  |
|  | 30 2         |  |

3

90

4

|  |    |   |   |
|--|----|---|---|
|  |    |   |   |
|  |    |   |   |
|  | 10 |   | 5 |
|  |    | 5 |   |

|  |  |    |  |              |   |
|--|--|----|--|--------------|---|
|  |  | 10 |  | 5<br>5       | 0 |
|  |  | 15 |  | 1            |   |
|  |  | 15 |  | 5<br>10<br>5 |   |
|  |  | 10 |  | 5<br>5<br>1  |   |
|  |  | 10 |  | 5            |   |
|  |  | 15 |  | 1<br>10      |   |
|  |  | 15 |  | 2<br>5       |   |
|  |  | 15 |  | 1<br>10<br>1 |   |

22.

4-22

1

1

C

B

A

3

11 19

A

11 20

11 20

A

C

11 27

C 11 27

A

A11 28

11 28

B

A

17 30

A A

11

29

A

B9 15

A

A

11 29

9 30 A

28

11 29

10 15

3

4

B

A

11 29

14 00 A

C

C

A

11 29 14 15 A

B

A

A

A

A

1

A

2

A

3

4

5

6

7

?

8

2

2

|  |    |            |
|--|----|------------|
|  |    |            |
|  | 1  | 30         |
|  | 1  | 30 40<br>0 |
|  | 5  |            |
|  | 30 |            |
|  | 30 | 2          |

3

90

4

|  |    |  |    |   |
|--|----|--|----|---|
|  |    |  |    |   |
|  |    |  |    |   |
|  | 10 |  | 5  |   |
|  |    |  | 5  |   |
|  | 10 |  | 5  | 0 |
|  |    |  | 5  |   |
|  | 15 |  | 1  |   |
|  |    |  | 5  |   |
|  | 15 |  | 10 |   |
|  |    |  | 5  |   |
|  | 10 |  | 5  |   |
|  |    |  | 5  |   |



|  |  |    |  |   |   |    |
|--|--|----|--|---|---|----|
|  |  |    |  | 1 | 5 |    |
|  |  | 10 |  | 5 |   | 5  |
|  |  | 15 |  | 5 | 1 | 10 |
|  |  | 15 |  | 5 | 2 | 5  |
|  |  | 15 |  |   | 1 | 10 |
|  |  |    |  |   | 1 |    |

23.

4-23

1

1

7 23

3

705

7

02231234567

4

02411234567

234

3 20

10

1

2

3

4

5

6

7

8

?

2

2

|  |    |            |
|--|----|------------|
|  |    |            |
|  | 1  | 30         |
|  | 1  | 30 40<br>0 |
|  | 5  |            |
|  | 30 |            |
|  | 30 | 2          |

3

90

4

|  |    |  |   |   |
|--|----|--|---|---|
|  |    |  |   |   |
|  |    |  |   |   |
|  | 10 |  | 5 |   |
|  | 10 |  | 5 | 0 |
|  | 15 |  | 1 |   |

|  |    |  |  |              |         |
|--|----|--|--|--------------|---------|
|  |    |  |  |              |         |
|  | 15 |  |  | 5<br>10<br>5 |         |
|  | 10 |  |  | 5<br>5<br>1  | 5       |
|  | 10 |  |  | 5<br>1       | 5       |
|  | 15 |  |  | 2<br>5       | 10      |
|  | 15 |  |  | 1<br>1       | 5<br>10 |

24.

4-24

1

1

9

500

10

8

2

15 /

10

14 /

2014

9

12

\*\*

3

1

2

3

4

?

5

6

7

?

8

2

2

|  |    |            |
|--|----|------------|
|  |    |            |
|  | 1  | 30         |
|  | 1  | 30 40<br>0 |
|  | 5  |            |
|  | 30 |            |
|  | 30 | 2          |

3

90

4

|  |    |  |   |   |
|--|----|--|---|---|
|  |    |  |   |   |
|  |    |  |   |   |
|  | 10 |  | 5 |   |
|  | 10 |  | 5 | 0 |
|  | 15 |  | 1 |   |

|  |  |    |  |              |         |
|--|--|----|--|--------------|---------|
|  |  | 15 |  | 5<br>10<br>5 |         |
|  |  | 10 |  | 5<br>5<br>1  | 5       |
|  |  | 10 |  | 5<br>1       | 5       |
|  |  | 15 |  | 2<br>5       | 10      |
|  |  | 15 |  | 1<br>1       | 5<br>10 |

25.

4-25

1

1

9

6 300

5 250

5

500

500

15000

6

300

4700

2

600



1

2

3

4

?

5

6

7

?

8

2

**2**

|  |                |  |
|--|----------------|--|
|  |                |  |
|  | 1 30           |  |
|  | 1 30 40<br>5 0 |  |
|  | 30             |  |
|  | 30 2           |  |

**3**

90

**4**

|       |
|-------|
| _____ |
|-------|

